

OC1

DIVE COMPUTER

OPERATING MANUAL

CONTENTS

NOTICES.....	3	DIVE MODE FEATURES	26
FEATURES AND FUNCTIONS.....	5	NORM Dive Mode Structure	27
DISPLAY LAYOUT.....	6	PROXIMITY OF THE TMTS AND OC1.....	27
ABBREVIATIONS.....	6	Link Interruption Underwater.....	27
INITIAL ACTIVATION.....	6	WET ACTIVATION	28
OVERVIEW.....	7	BACKLIGHT	28
MENU SYSTEM.....	7	BAR GRAPHS	28
OPERATING MODE STRUCTURES	8	TLBG.....	28
AUDIBLE ALARM.....	9	O2BG.....	28
PC INTERFACE.....	9	VARI.....	28
POWER SUPPLY, BATTERY STATUS.....	10	ALGORITHM (NDL BASIS).....	29
WATCH MODE.....	11	CONSERVATIVE FACTOR.....	29
WATCH DEFAULT TIME.....	12	DEEP STOP	29
WATCH MENU.....	12	SAFETY STOP.....	29
Countdown Timer.....	12	OVERVIEW OF FO2 SETTINGS AND 50% DEFAULT	29
Chronograph.....	13	Setting FO2 for NORM Nitrox Dives	29
Daily Alarm.....	13	FO2 set for Air.....	30
Set Time Menu.....	14	FO2 set for Nitrox	30
Set Date Format.....	14	DIVE TIME REMAINING (DTR)	30
Set Hour Format	14	No Deco DTR (NDC)	30
Set Time	14	O2 DTR (OTR)	30
Set Date.....	14	Air Time Remaining (ATR)	30
Set Alternate Time	14	ERROR (RESET DURING DIVE).....	31
Select Default Time	15	NORM DIVE MODES	32
NORM SURFACE MODES	16	NO DECO MAIN AND ALTS.....	33
Dive Computer Operating Modes	17	DEEP STOP	33
NORM Surface Functions	17	SAFETY STOP.....	34
NORM SURF MAIN AND ALTS.....	18	DECOMPRESSION	34
NORM MENU	18	VIOLATION MODES	35
Fly/Dsat Time	18	HIGH PO2	37
NORM Plan Mode	19	HIGH O2.....	38
NORM/GAUG Log Mode.....	19	GAS/TMT SWITCHING.....	40
Set F (FO2) Menu.....	20	DIGITAL GAUGE MODE	43
Set FO2 Gas 1.....	20	GAUG SURFACE MAIN AND ALTS.....	44
Set FO2 Gas 2.....	20	GAUG MENU	44
Set FO2 Gas 3.....	21	Fly Time.....	44
Set FO2 Default.....	21	Select Dive Mode.....	44
Set A (Alarms) Menu.....	21	GAUG DIVE MAIN AND ALT	45
Set Audible Alarm.....	21	Delayed Violation.....	45
Set Depth Alarm.....	21	FREE DIVE MODE.....	46
Set EDT Alarm.....	21	FREE SURFACE MAIN AND ALTS.....	47
Set TLBG Alarm.....	22	FREE MENU	48
Set DTR Alarm	22	Countdown Timer.....	48
Set Turn Press Alarm	22	Set CDT	48
Set End Press Alarm	22	Elapsed Dive Time Alarm.....	48
Set PO2 Alarm.....	22	Set EDT Alarm.....	48
Set U (Utilities) Menu	22	Descending Depth Alarms.....	48
Set Wet Activation	22	Set DD Alarms.....	48
Set Units.....	23	Select Dive Mode.....	49
Set Deep Stop.....	23	FREE DIVE MAIN AND ALTS.....	50
Set Safety Stop.....	23	FREE DIVE ALARMS	50
Set NDL Basis.....	23	COMPASS MODE.....	52
Set Conservative Factor	23	OVERVIEW	54
Set Glo (Backlight) Duration	23	COMPASS MENU	54
Set Sampling Rate.....	24	Calibration.....	54
Set TMT Menu.....	24	North OP Mode	55
Set TMT 1	24	Reference OP Mode.....	55
Set TMT 2, 3	24	Set Reference Heading	55
Select Dive Mode.....	25	Declination	55
NORM/GAUG History Mode.....	25	Set Declination	55
Serial Number.....	25	COMPASS OPERATION	56
Battery/TMT Status.....	25		

CONTENTS (continued)

REFERENCE 57

 PC INTERFACE 58

 PC Requirements 58

CARE AND CLEANING 59

INSPECTIONS AND SERVICE 59

BATTERY REPLACEMENT 59

 Data Retention 59

TRANSMITTER 61

ALTITUDE SENSING AND ADJUSTMENT 61

TECHNICAL DATA 62

 PZ+ ALGORITHM NDL CHART 63

 DSAT ALGORITHM NDL CHART 63

 SPECIFICATIONS 64

 FCC COMPLIANCE 65

INSPECTION/SERVICE RECORD 66

OCEANIC WORLD WIDE 66

NOTICES

LIMITED TWO-YEAR WARRANTY

For details, refer to the Product Warranty Registration Card provided. Register on-line at www.OceanicWorldwide.com

COPYRIGHT NOTICE

This operating manual is copyrighted, all rights are reserved. It may not, in whole or in part, be copied, photocopied, reproduced, translated, or reduced to any electronic medium or machine readable form without prior consent in writing from Oceanic/2002 Design.

OC1 Operating Manual, Doc. No. 12-2761
 © 2002 Design, 2009
 San Leandro, CA USA 94577

TRADEMARK, TRADE NAME, AND SERVICE MARK NOTICE

Oceanic, the Oceanic logo type, OC1, the OC1 logo, Air Time Remaining (ATR), Diver Replaceable Batteries, Graphic Diver Interface, Tissue Loading Bar Graph (TLBG), Pre Dive Planning Sequence (PDPS), Set Point, Control Console, Turn Gas Alarm, and OceanLog are all registered and unregistered trademarks, trade names, and service marks of Oceanic. All rights are reserved.

PATENT NOTICE

U.S. Patents have been issued, or applied for, to protect the following design features:
 Dive Computer with Free Dive Mode and/or Wireless Data Transmission [U.S. Patent no. 7,797,124], Air Time Remaining [U.S. Patent no. 4,586,136 and 6,543,444] and Data Sensing and Processing Device [U.S. Patent no. 4,882,678]. Set TLBG Alarm and other patents pending. User Setable Display [U.S. Patent no. 5,845,235] is owned by Suunto Oy (Finland).

DECOMPRESSION MODEL

The programs within the OC1 simulate the absorption of nitrogen into the body by using a mathematical model. This model is merely a way to apply a limited set of data to a large range of experiences. The OC1 dive computer model is based upon the latest research and experiments in decompression theory. **Still, using the OC1, just as using the U.S. Navy (or other) No Decompression Tables, is no guarantee of avoiding decompression sickness, i.e. "the bends."** Every diver's physiology is different, and can even vary from day to day. No machine can predict how your body will react to a particular dive profile.

Welcome
to
OCEANIC
and
THANK YOU
for choosing the
OC1

FEATURES AND FUNCTIONS

DISPLAY LAYOUT

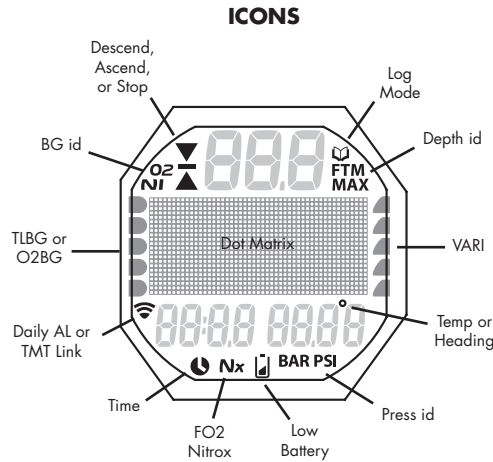

DISPLAY ABBREVIATIONS

ACTIV	= Activation	NDC	= No Deco DTR
AL	= Alarm	NDL	= No Deco Limit
ALT	= Alternate (watch time)	NE	= Northeast (compass)
ATR	= Air Time Remaining	NO	= Number
AUD	= Audible	NO-D	= No Decompression
AVAIL	= Available	NORM	= Normal Dive Mode
BATT	= Battery	NW	= Northwest (compass)
CAL	= Calibrate (compass)	O2	= Oxygen
CDT (CD)	= Countdown Timer	OTR	= O2 DTR
CHRONO	= Chronograph (stop watch)	PO2	= Partial Pressure of O2 (ATA)
CONSERV	= Conservative Factor	PRESS	= Pressure
DD	= Descending Depth (alarm)	PZ+	= Algorithm type
DECO	= Decompression	REF	= Reference (compass)
DFLT	= Default	S	= South (compass)
DSAT	= Desaturation (or Algorithm type)	SAFE	= Safety (stop)
DTR	= Dive Time Remaining	SE	= Southeast (compass)
DURA	= Duration (backlight)	SEC	= Seconds (time)
E	= East (compass)	SET A	= Set Alarms
EDT	= Elapsed Dive Time	SET F	= Set FO2 items
EL	= Elevation (altitude)	SET U	= Set Utilities
FO2	= Fraction of Oxygen (%)	SN	= Serial Number
FORM	= Format (date, time)	SURF	= Surface
FREE	= Free Dive Mode	SW	= Southwest (compass)
FT	= Feet (depth)	SWCH	= Switch (gas)
GAUG	= Digital Gauge Dive Mode	TAT	= Total Ascent Time (deco)
GLO	= Glow (backlight)	TLBG	= Tissue Loading Bar Graph
HIST	= History	TMR	= Timer
LO	= Low (battery)	TMT	= Transmitter
M	= Meters (depth)	VIOL	= Violation
MIN	= Minutes (time)	W	= West (compass)
N	= North (compass)		

INITIAL ACTIVATION

OC1 Watch/Dive Computers are placed in a Deep Sleep mode prior to being shipped from the factory. The intent is to extend storage life of the Battery for up to 7 years, before the unit is initially placed in service.

In this mode, Date and Time are updated as they normally would be. However, they are not displayed. Upon waking the OC1 up, the correct Date and USA Pacific Time will be displayed and it will be ready to operate with full functions.

To wake the OC1 up from Deep Sleep mode, simultaneously depress the upper/right (S) and lower/left (A) buttons for 3 seconds until the display comes full ON displaying the Watch Main Time screen, then release them.

△ NOTE: Once the OC1 is brought out of the Deep Sleep mode, it can only be placed back into it by the factory.

OVERVIEW

The OC1 is a fully loaded Watch Dive Computer featuring >>

- 4 Control Buttons
- 10 Menus
- 40 Set Selections
- Increase/Decrease Set Values
- 5 Operating Modes
- 3 Nitrox Gas Mixes
- 35 Warnings/Alarms
- Dual Watch Time
- Dual Algorithm
- Gas/TMT Switching
- No Deco Deep Stop
- No Deco Safety Stop
- Gauge Depths to 660 FT/200 M
- Gauge Dive Run Timer
- Digital Compass
- Altitude Compensation
- NDL Conservative Factor
- Variable Ascent Rate
- PC Settings Upload/Data Download
- Audible Alarm with flashing LED
- User Replaceable Battery
- User Upgradeable Firmware

INTERACTIVE CONTROL CONSOLE

The Interactive Control Console utilizes 4 control buttons that allow you to maneuver through the OC1's unique system of menus.

The buttons will be referred to as M, S, L, and A.

- Upper/Left - Mode (M) button
- Upper/Right - Select (S) button
- Lower/Right - Light (L) button
- Lower/Left - Advance (A) button

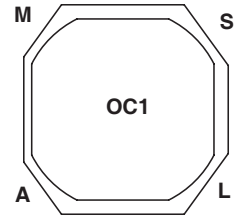

MENU SYSTEM

The Dot Matrix located in the middle of the LCD viewing area is used to display alpha numeric messages and measured values as well as Menu type systems for selection of settings and various auxiliary functions. It also serves as the Digital Compass which can be accessed during operation in any mode.

There are 10 Menus that include the -

- Watch Menu
- Set Time Menu
- NORM Menu
- GAUG Menu
- FREE Menu
- Compass Menu
- Set F Menu
- Set A Menu
- Set U Menu
- Set TMT Menu

Each Menu has a Start (First) selection and a Stop (Last) selection. Upon entering a Menu, movement through it starts at the Start (First) selection, then continues in a rolling manner down the screen showing selections in groups of 3.

- The sample at the right shows how a menu would look if all of the selections would be displayed on one screen.

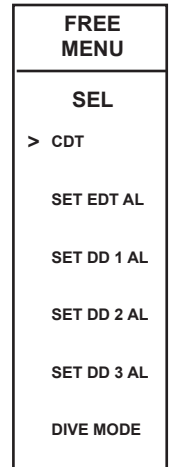

Sample Menu
(all selections shown)

Menu button action >>

- M (< 2 sec) - to access Menu
- A (< 2 sec) - to step down the screen (forward) through selections
- M (< 2 sec) - to step up the screen (backward) through selections
- S (< 2 sec) - to access selection indicated by Arrow icon (>)

Right Arrow icon (>) at the left indicates the selection.

Down Arrow icon (v) at the right indicates that additional selections are available below (after) those shown.

Up Arrow icon (^) at the right indicates that additional selections are available above (before) those shown.

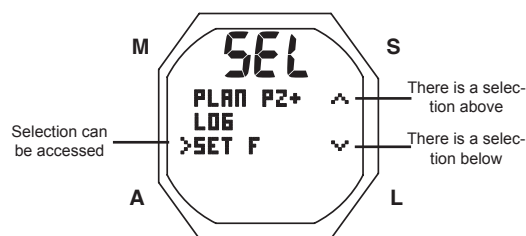

WATCH MODE STRUCTURE

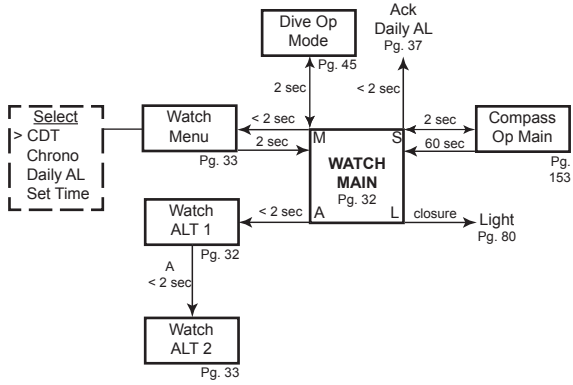

NORM SURFACE MODE STRUCTURE

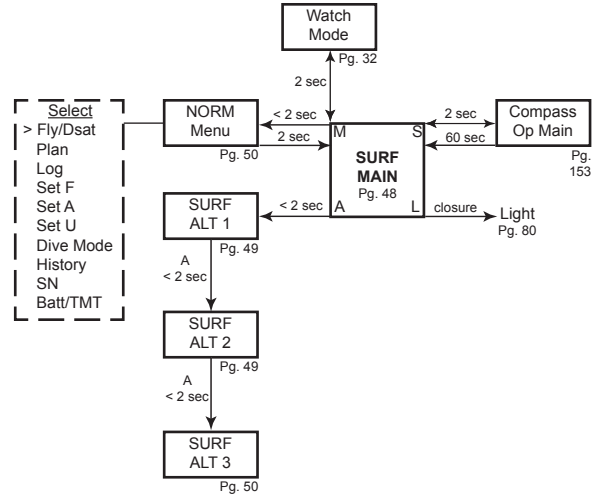

WATCH/NORM/GAUG SET MODE STRUCTURE

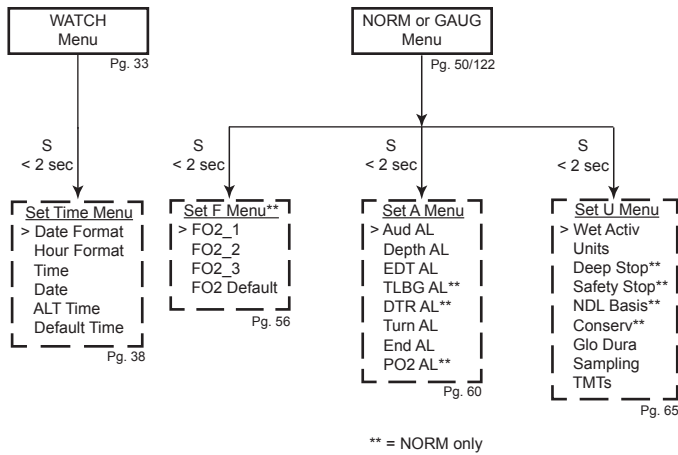

GAUG SURFACE MODE STRUCTURE

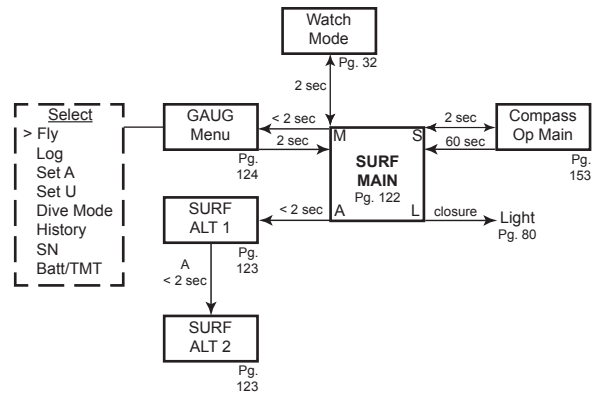

COMPASS MODE STRUCTURE SURFACE

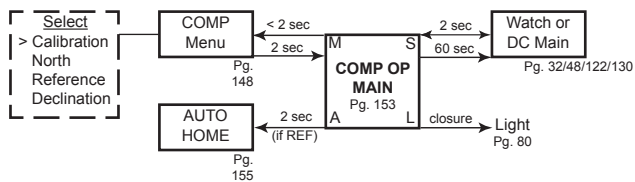

FREE SURF MODE STRUCTURE

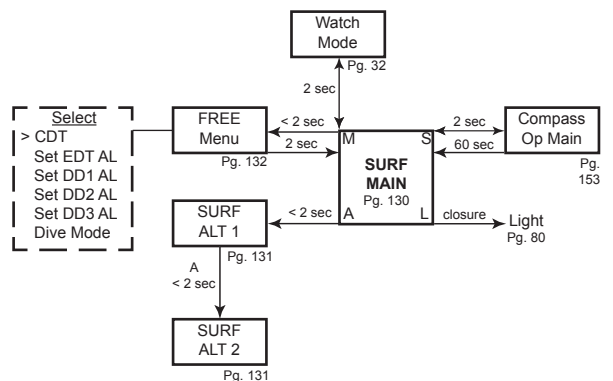

AUDIBLE ALARM

While operating in NORM or GAUG Mode the Audible will emit 1 beep per second for 10 seconds when alarms strike, unless it is set Off. During that time, the Audible can be acknowledged and silenced by pressing the S button (less than 2 seconds).

A LED Warning Light, on the lower end of the housing, is synchronized with the Audible and flashes as the Audible sounds. It will turn Off when the Alarm is silenced. The Audible and LED will not be active if the Audible is Set OFF (a group A setting).

FREE Dive Mode has its own set of Alarms which emit 3 short beeps either 1 or 3 times which cannot be acknowledged or set Off.

Situations that will activate the NORM/GAUG 10 second Alarm include -

** Items activate only in NORM mode.

- Air Time Remaining (ATR) at 5 minutes, then again at 0 minutes.
- Turn Pressure at the Set Point selected (Transmitter 1 only).
- End Pressure at the Set Point selected (active Transmitter).
- Descent deeper than the Depth Alarm Set Point selected.
- Dive Time Remaining at the Set Point selected**.
- Elapsed Dive Time at the Set Point selected.
- PO2 at the Set Point selected**.
- High O2 of 300 OTU (100%)**.
- TLBG at the Set Point selected**.
- Ascent Rate exceeds 60 FPM (18 MPM) when deeper than 60 FT (18 M), or 30 FPM (9 MPM) at 60 FT (18 M) and shallower.
- Loss of the active Transmitter Link signal for more than 15 seconds during a dive.
- Entry into Decompression Mode (Deco)**.
- Conditional Violation (above a required Deco Stop Depth for less than 5 minutes)**.
- Delayed Violation (above a required Deco Stop Depth for more than 5 minutes)**.
- Delayed Violation (a Deco Stop Depth greater than 60 FT/18 M is required)**.
- Delayed Violation (Max Operating Depth of 330 FT/100 M is exceeded).
- A Gas Switch would expose the diver to PO2 => 1.60 ATA**.
- Watch Daily Alarm reaches time set (disabled during Dive Modes).
- Watch Mode Countdown Timer reaches 0:00.

A single short beep (which cannot be disabled) sounds when -

- After 5 minutes on the surface after the Violation dive.

3 short beeps (which cannot be disabled) sound when -

- Ascent Rate is 51 to 60 FPM (15.1 to 18 MPM) when deeper than 60 FT (18 M), or 26 to 30 FPM (7.5 to 9 MPM) at 60 FT (18 M) and shallower.
- FREE Dive Elapsed Dive Time Alarm (3 beeps every 30 seconds if set On).
- FREE Dive Depth Alarms 1, 2, 3 (set sequentially deeper) - each 3 beeps 3 times.
- FREE Dive TLBG Alarm (Caution zone, 4 segments) - 3 beeps 3 times.
- Entry into Deco during a FREE Dive (Violation) - 3 beeps 3 times.
- Free Dive Mode Countdown Timer reaches 0:00 - 3 beeps 3 times.

During the following NORM Dive situations, the 10 second continuous tone will be followed by a 5 second steady beep that will not turn off when acknowledged -

- Ascent above a Deco Stop for more than 5 minutes.
- Deco requires a Stop Depth of 70 FT/21 M or deeper.
- On the Surface for 5 minutes after a Conditional Violation.

PC INTERFACE

Interface with a PC, to allow uploading settings and downloading data, is accomplished by connecting the OC1 to a PC USB Port using the special OC1 USB Interface Cable.

The software program together with the USB Driver required is on the Oceanlog CD, and can be downloaded from the OceanicWorldwide web site. The program's HELP** serves as the user manual which can be printed for personal use.

** Prior to attempting to Download data from your OC1 or Upload Settings to it, review the HELP section of the Oceanlog program. Recommended is to print those sections of HELP that you consider appropriate for your Interface activities.

The Settings Upload portion of the Oceanlog program can be used to set/change the Main Time, Date, Set A group (Alarms), and Set U group (Utilities) using the same Interface System. FO2 and FREE Mode related items must be set using the control buttons.

Information available for retrieval (download) from the OC1 to the PC Download portion of the program includes dive data such as number, surface interval time, maximum depth, elapsed dive time, no deco status, pressure, start date/time, lowest temperature under water, sampling rate, dive profile, and Set Points.

The Oceanlog program also allows upgrade of select versions of the OC1's firmware (operating system software) after which the OC1 resets all operating data. Since the upgrades require reset of the OC1, they are blocked during 24 hours after dives.

- Refer to page 58 for more details relating to Oceanlog and PC Interface.

POWER SUPPLY

- OC1 (Watch) Battery >> (1) 3 vdc, CR2450, Lithium battery
- Shelf life >> up to 7 years (when shipped from factory in Deep Sleep mode)
- OC1 use life >> 1 year or 300 dive hours if (2) 1 hour dives per dive day
- TMT (Transmitter) Battery >> (1) 3 vdc, CR2, .75 Ahr, Lithium battery
- TMT use life >> 300 dive hours if (2) 1 hour dives per dive day
- Replacement >> user replaceable (annual recommended)

Battery icon (OC1 only):

- Warning >> icon on solid < 2.75 volts, battery change recommended
- Alarm >> icon on flashing < 2.50 volts, change the battery

BATTERY STATUS

To access, while viewing NORM (or GAUG) SURF Main >>

- M (< 2 sec) to access Menu
- A (< 2 sec), repeat until (>) is next to BATT/TMT
- S (< 2 sec) activates Receiver, then OC1 Status appears for 3 sec (Fig. 1A), then each TMT Status for 3 sec (Fig. 1B).

OC1 LOW BATTERY WHILE ON THE SURFACE

<= 2.75 volts (warning level)

- Backlight is completely disabled.
- Battery icon (shell with inner bar) appears solid (Fig. 2a).
- If a dive is started, the icon is not displayed on the dive mode screens.
- Watch and DC functions, including Compass Mode, continue to be available.

<=2.50 volts (Too Low - alarm level)

- All DC operations cease and unit operates only as a Watch with Compass (view only).
- Low Battery icon (shell only with no inner bar) flashes for 5 seconds and operation reverts to Watch Time with Compass allowed (view only) until the Battery is changed or voltage cannot sustain operation, then the graphic CHANGE BATTERY flashes (Fig. 3) until the Battery is changed or voltage drops to the level at which operation cannot be maintained.

OC1 LOW BATTERY DURING A DIVE

<= 2.75 volts (warning level)

- Backlight is completely disabled.
- Full DC functions and Compass continue to be available.
- Battery icon is not displayed on the dive mode screens.
- Battery icon (shell with inner bar) appears solid upon entry into Surface Mode.

<= 2.50 volts (Too Low - alarm level)

- Backlight is completely disabled.
- Full DC functions continue to be available during the dive.
- Battery icon is not displayed on the dive mode screens.
- Upon entry into Surface Mode, the Battery icon (shell only with no inner bar) and graphic CHANGE BATTERY flash for 5 seconds (Fig. 4) and operation reverts to Watch Time (Fig. 5), with Compass (view only) allowed, until the Battery is changed or voltage cannot sustain operation, then the graphic CHANGE BATTERY flashes until the Battery is changed or voltage drops to the level at which operation cannot be maintained.

TMT (TRANSMITTER) LOW BATTERY

Indication is provided only while on the surface.

<= 2.75 volts (warning level)

- The graphics TMTx BATT and LO appear solid on the Battery Status screen (Fig. 6).
- DC functions continue to be available (surface and dive).

<= 2.50 volts (Too Low - alarm level)

- The graphics TMTx BATT and LO alternate with the graphics DIVE xx and NORM (or GAUG) on the NORM (or GAUG) SURF Main screen (Fig. 7).
- The graphics TMTx BATT and LO also flash on the Battery Status screen.
- TMT operation continues until Tank Pressure decreases to 50 PSI.



Fig. 1A - OC1 BATTERY STATUS

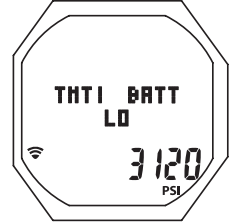

Fig. 1B - TMT BATTERY STATUS

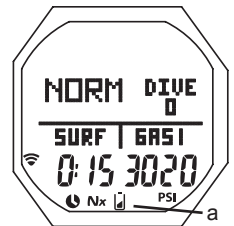

Fig. 2 - OC1 LOW BATT WARNING

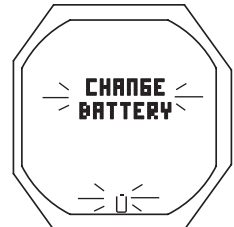

Fig. 3 - OC1 LOW BATT ALARM

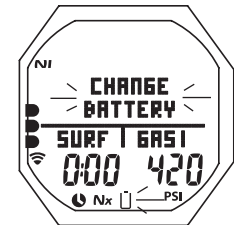

Fig. 4 - LOW BATT ALARM (after surfacing)



Fig. 5 - WATCH MODE (Low Batt Alarm)



Fig. 6 - TMT BATT STATUS



Fig. 7 - NORM SURF MAIN

WATCH MODE

WATCH DEFAULT TIME

Default Time is the Time that is displayed on the Watch until changed. It is also the Time viewed during operation in DC (Dive Computer) Modes.

Main Time is the current Time at your home location and is normally selected as the Watch Default Time.

Alternate Time, set by Hour Differential, is the current Time at a remote travel location. Upon arrival at the location, Alternate Time can be interchanged with Main Time to make it the Default Time while visiting the travel location.

Setting Time of Day and Alternate Time, and selection of which is to be the Default Time displayed are functions in the Watch Set Time Menu.

Once Alternate Time is set, by Hour Differential, it will automatically change when Time of Day is set/changed. When Alternate Time is selected to be the Watch Default Time (while at a travel location), it will change directly when Time of Day is changed and Main (home) Time will then change by a differential opposite the one set for Alternate Time.

M 2 seconds, or no button action during 2 minutes, while operating in any Watch sub routine, will revert to the Watch Default Time screen.

Default Time, information includes (Fig. 8):

- > Time of Day (hr:min:sec), Home (or Alternate if selected)
- > Day of Week graphic MON, TUE, WED, THU, FRI, SAT, or SUN
- > Graphic ALT, if Alternate Time is selected as Default
- > Month.Day (or Day.Month)
- > Battery icon, if a Low Battery
- > Alarm (speaker) icon, if Daily Alarm is set On
- > TLBG, if any after NORM/FREE dives

- A < 2 sec to access Watch ALTs
- M < 2 sec to access Watch Menu
- M 2 sec to access DC (Dive Computer) Mode
- S < 2 sec to silence Daily Alarm
- S 2 sec to access Compass
- L (on closure) to activate Backlight

Alt 1, information includes (Fig. 9):

- > Time of Day (hr:min:sec), Alternate (or Home if selected)
- > Day of Week graphic MON, TUE, WED, THU, FRI, SAT, or SUN
- > Graphic ALT, blank if Home Time is displayed
- > Month.Day (or Day.Month)
- > Battery icon, if a Low Battery
- > Alarm (speaker) icon, if Daily Alarm is set On
- > TLBG, if any after NORM/FREE dives.

- A < 2 sec to access ALT 2
- 5 sec reverts to Watch Default if A is not pressed
- L (on closure) to activate Backlight

Alt 2, information includes (Fig. 10):

- > Altitude graphic EL2 (to EL 7), blank if Sea level
- > Temperature with ° icon and graphic F (or C)

- 5 sec, or A < 2 sec, revert to Watch Default
- L (on closure) to activate Backlight

WATCH MENU

- M (< 2 sec) - to access Menu, while viewing Default Time.
- A (< 2 sec) - to step down (forward) through selections.
- M (< 2 sec) - to step up (backward) through selections.
- S (< 2 sec) - to access selection indicated by Arrow icon (>).

CDT (Countdown Timer) STATUS

Upon access, the following is displayed (Fig. 11) -

- > Graphics CD TMR solid with OFF (or ON) flashing.
- > Countdown Time (hr:min). If OFF, 0:00 or the CDT time if previously set. If ON, the remaining time (hr:min).

- A < 2 sec to step through selections OFF, ON, and SET.
- S < 2 sec to save the selection that is flashing.

- >> If OFF is selected, operation reverts to the Menu.
- >> If ON is selected, operation reverts to the Menu with the time set starting to countdown.
- >> If SET is selected (Fig. 12), Set CDT is accessed.

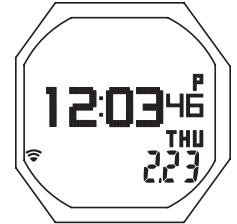

Fig. 8 - DEFAULT TIME

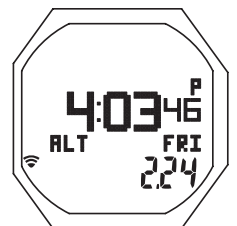

Fig. 9 - WATCH ALT 1

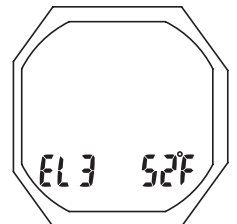

Fig. 10 - WATCH ALT 2

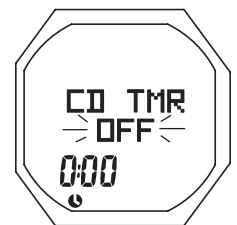

Fig. 11 - CDT STATUS (upon access)

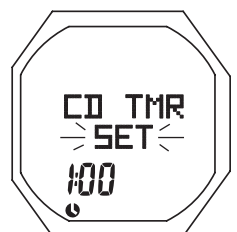

Fig. 12 - CDT STATUS (to access Set, or set/ready)

Set CDT, information includes (Fig. 13):

- > Graphics SET and CD TMR
- > CDT (hr:min) with Hour digits flashing
- > Time (clock) icon

- A (hold) to scroll upward through Hour Set Points at a rate of 8 per second from 0: to 23: in increments of 1: (hr).
- A (< 2 sec) to step upward through Set Points one at a time.
- M (< 2 sec) to step back through Set Points one at a time.
- S (< 2 sec) to save the Hour Set Point and flash the Minute digits.
- A (hold) to scroll upward through Minute Set Points at a rate of 8 per second from :00 to :59 in increments of :01 (min).
- A (< 2 sec) to step upward through Set Points one at a time
- M (< 2 sec) to step back through Set Points one at a time.
- S (< 2 sec) to save the CDT Set Point and revert to the CDT Status screen with SET flashing (similar to Fig. 12).

The CDT will run in the background, while in Watch mode, until it counts down to 0:00, or it is set OFF, or DC Mode is accessed or a Dive is started in which case the CD will terminate and revert to OFF.

When a set Countdown Time reaches 0:00, the Audible Alarm will sound during which time the graphic CDT will be displayed on the watch Default Time screen with 0:00 flashing (Fig. 14).

FREE Dive Mode has a separate (min:sec) CDT.

CHRONOGRAPH (Stop Watch/Lap Timer)

Upon access from the Menu, the Status screen is displayed

- > OFF solid and 0:00, if no time was previously set
- > ON and the remaining Countdown Time (hr:min), if running
- > OFF flashing and the time previously set, if it has ended

Chrono Status, information includes (Fig. 15):

- > Graphic CHRONO
- > Elapsed time if running, or 0:00:00.00 (hr:min:sec .01 sec)
- > Time (clock) icon
- S (< 2 sec) to start Timer counting up from 0:00:00.00 to 9:59:59.99 max (hr:min:sec .01 sec) in increments of .01 (1/100th sec). After first 4.99 seconds, the .01 digits display 2 dashes (- -).
- S (< 2 sec) to freeze and display Laps (up to 9), the Timer continues to run in the background
- A (< 2 sec) to stop Timer and recall Lap 1 (Fig. 16), repeat to recall other Laps
- A (2 sec) to reset Timer to 0:00:00.00 and revert to the Chrono Status screen

While the Chronograph is running, it remains on the screen until another screen is accessed, it will then continue to run in the background while on the surface. Upon descending on a dive, Chrono operation will be terminated and reset to 0:00:00.00.

DAILY ALARM

When set On, the Daily Alarm will -

- > be synchronized with the Watch Default Time selected.
- > sound the Audible at the Time set every day.
- > not sound the Audible while operating in DC Modes.
- > run in the background until set Off.

Daily Alarm Status

Upon access, the following is displayed (Fig. 17) -

- > Graphics DAILY AL solid with OFF (or ON) flashing.
- > Alarm Time (hr:min) set with graphic A (or P) if 12 Hour Format, and Time (clock) and Alarm (speaker) icons.

- A < 2 sec to step through selections OFF, ON, and SET.
- S < 2 sec to save the selection that is flashing.
- >> If OFF is selected, operation reverts to the Menu.
- >> If ON is selected, operation reverts to the Menu with the Alarm enabled.
- >> If SET is selected (Fig. 18), Set Daily Alarm is accessed.

Set Daily Alarm, information includes (Fig. 19):

- > Graphics SET and DAILY AL
- > Alarm Time (hr:min) with Hour digits flashing
- > Time (clock) and Alarm (speaker) icons

- A (hold) to scroll upward through Hour Set Points at a rate of 8 per second from 0: to 23: in increments of 1: (hr).
- A (< 2 sec) to step upward through Set Points one at a time.
- M (< 2 sec) to step back through Set Points one at a time.
- S (< 2 sec) to save the Hour Set Point and flash the Minute digits.
- A (hold) to scroll upward through Minute Set Points at a rate of 8 per second from :00 to :59 in increments of :01 (min).
- A (< 2 sec) to step upward through Set Points one at a time
- M (< 2 sec) to step back through Set Points one at a time.
- S (< 2 sec) to save the Set Point and revert to the Daily Alarm Status screen with SET flashing (similar to Fig. 18).

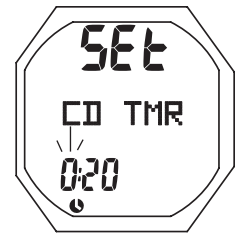

Fig. 13 - SET CDT

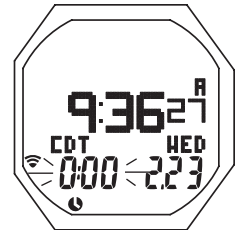

Fig. 14 - WATCH MAIN (during CDT Alarm)



Fig. 15 - CHRONO (started, running)



Fig. 16 - CHRONO (started, frozen or recalled)



Fig. 17 - DAILY ALARM STATUS (upon access)



Fig. 18 - DAILY AL STATUS (to access Set or set/ready)

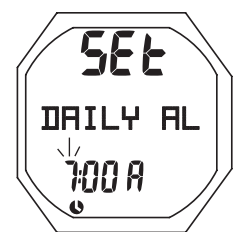

Fig. 19 - SET ALARM TIME

SET TIME MENU

- S (< 2 sec) to access Set Time Menu, while the selection Arrow icon (>) is next to Set Time on the Watch Menu
- A (< 2 sec) to step down (forward) through selections
- M (< 2 sec) to step up (back) through selections
- S (< 2 sec) to access selection indicated by Arrow icon (>)

Set Date Format, information includes (Fig. 20):

Date Format establishes the location that the Month (M) digits are displayed relative to the Day (D) digits, on the left or right.

- > Graphic DATE FORMAT
- > Set Point graphics MNTH.DAY and DAY.MNTH; Arrow (>) icon next to the one previously saved flashing

- A (< 2 sec) to toggle Set Points
- S (< 2 sec) to save Set Point and revert to Set Time Menu

Set Hour Format, information includes (Fig. 21):

- > Graphic HOUR FORMAT
- > Set Point graphics 12 and 24; Arrow (>) icon next to the one previously saved flashing

- A (< 2 sec) to toggle Set Points
- S (< 2 sec) to save Set Point and revert to Set Time Menu

Set Time of Day, information includes (Fig. 22):

This setting directly changes the Time of Day that is selected to be the Watch Default Time, whether it is Main (home) Time or Alternate (travel location) Time. The other will be changed by the Time Differential set.

- > Graphic TIME
- > Time of Day (hr:min), Hour digits flashing, with graphic A (or P) if 12 Hour Format
- > Graphic ALT, if Alternate is Default Time (at travel location)

- A (hold) to scroll upward through Hour Set Points at a rate of 8 per second from 12: A to 11: P, or 0: to 23: if 24 Hour Format, in increments of 1: (hr)
- A (< 2 sec) to step upward through Set Points one at a time
- M (< 2 sec) to step back through Set Points one at a time
- S (< 2 sec) to save the Hour Set Point and flash the Minute digits
- A (hold) to scroll upward through Minute Set Points at a rate of 8 per second from :00 to :59 in increments of :01 (min)
- A (< 2 sec) to step upward through Set Points one at a time
- M (< 2 sec) to step back through Set Points one at a time
- S (< 2 sec) to save the Time Set Point and revert to the Set Time Menu.

Set Date, information includes (Fig. 23):

The sequence for setting date is Year, then Month, then Day, regardless of the Date Format set.

- > Graphic DATE
- > Graphics YEAR MNTH.DAY (or (DAY.MNTH)
- > Date with Year digits flashing

- A (hold) to scroll upward through Year Set Points at a rate of 8 per second from 2008 to 2051, in increments of 1
- A (< 2 sec) to step upward through Set Points one at a time
- M (< 2 sec) to step back through Set Points one at a time
- S (< 2 sec) to save the Year Set Point and flash the Month digits
- A (hold) to scroll upward through Month Set Points at a rate of 8 per second from 1 to 12 in increments of 1
- A (< 2 sec) to step upward through Set Points one at a time
- M (< 2 sec) to step back through Set Points one at a time
- S (< 2 sec) to save the Month Set Point and flash the Day digits
- A (hold) to scroll upward through Day Set Points at a rate of 8 per second from 1 to 31 (max) in increments of 1
- A (< 2 sec) to step upward through Set Points one at a time
- M (< 2 sec) to step back through Set Points one at a time
- S (< 2 sec) to save the Date Set Point and revert to the Set Time Menu.

Set Alternate Time, information includes (Fig. 24):

This feature sets an Hour based numeric time Differential ranging from - 23 through 0 to + 23 (hours). Once the Differential is selected/saved, Alternate Time/Date values are based on the Time of Day Set Points unless changed while at a travel location with ALT Time selected as the Watch Default Time in which case Main (home) Time would change by a differential opposite to the one previously set for ALT Time.

- > Graphics SET and ALT TIME solid
- > Set Point graphic OFF, or the +/- numeric Hour Differential with graphic HR, all flashing

- A (hold) to scroll upward through Set Points at a rate of 8 per second from - 23 through 0 to + 23 in increments of 1
- A (< 2 sec) to step upward through Set Points one at a time
- M (< 2 sec) to step back through Set Points one at a time
- S (< 2 sec) to save the Differential Set Point and revert to the Set Time Menu.

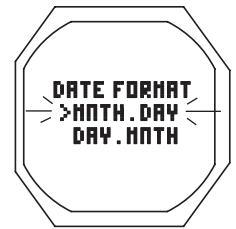

Fig. 20 - SET DATE FORMAT

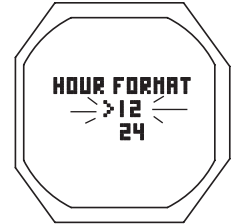

Fig. 21 - SET HOUR FORMAT

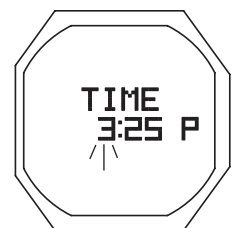

Fig. 22 - SET TIME



Fig. 23 - SET DATE

Day of the week is set automatically based on the Date set.

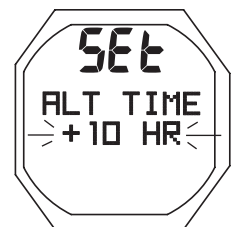

Fig. 24 - SET ALTERNATE TIME

Select Default Time, information includes (Fig. 25):

This feature selects whether Main (home) Time or Alternate (travel location) Time will be displayed as the Watch Default Time. The other will be displayed on the Watch ALT 1 screen.

- > Graphics SEL and DFLT TIME solid
- > Set Point graphics MAIN (home) and ALT (travel location, by Differential set); Arrow (>) icon next to the one previously saved flashing
- A (< 2 sec) to toggle Set Points
- S (< 2 sec) to save Set Point and revert to Set Time Menu



Fig. 25 - SET DEFAULT TIME

**SUMMARY OF
WATCH MODE OPERATIONS**

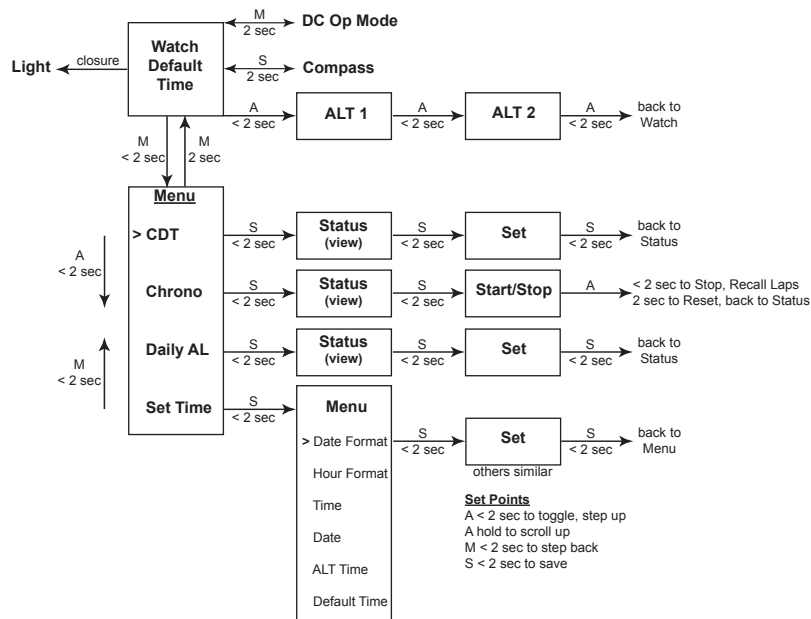

NORM

SURFACE MODES

NORM SURFACE FUNCTIONS

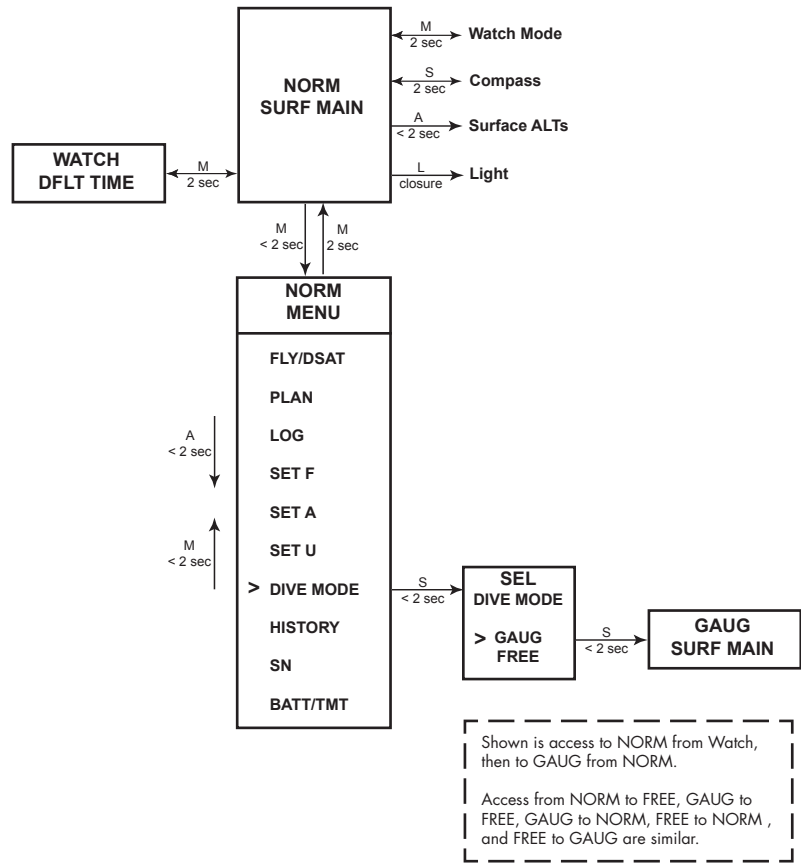

DIVE COMPUTER OPERATING MODES

NORM Mode >> for Air and Nitrox SCUBA activity with up to 3 Gases/3 TMTs
 GAUG Mode >> for SCUBA activity with up to 3 TMTs
 FREE Mode >> for breath hold diving activity with Depth/Time indication

If no previous dive has been taken within the past 24 hours, NORM is the default upon access from Watch Default Time. Others accessed as indicated at the left.

At any time while operating in Surface Modes, operation will enter the Dive Mode selected upon descent to 5 FT (1.5 M) for 5 seconds.

- When Wet Activation is set Off, Dive Mode will only be activated during operation in a DC Mode. It will not activate while in Watch Mode.
- When Wet Activation is set On, the selected Dive Mode will activate upon descent regardless of what mode it is operating in at the time.

Operation will revert from Dive Mode to Surface Mode upon ascent to 4 FT (1.2 M) for 1 second. The Surface Interval Time colon will flash during the first 10 minutes after a NORM/GAUG dive (Fig. 34), or 1 minute after a FREE dive.

A descent during the first 10 minutes after surfacing from a NORM or GAUG dive, or the first 1 minute after surfacing from a FREE dive, is a continuation of that dive. After the 10 minute (or 1 minute) interval has elapsed, a descent is then considered a new dive.

NORM SURF MAIN, information includes (Fig. 26A/B):

- > Graphic NORM
- > Graphic DIVE and number of dives completed during that operating period, up to 24 (0 if no dive made yet)
- > Graphic SURF and SI (hr:min) with Time (clock) icon; if no dive yet, this is time since access to NORM
- > Graphic GAS 1, default surface Gas, pre dive and 10 minutes after a dive
- > Nx icon, if any Gas is set for Nitrox
- > Tank Pressure with PSI (or BAR) icon, if the Receiver is successfully Linked with an active TMT (Transmitter), 000 flashing after 15 seconds of lost Link
- > Link icon, if the Receiver is successfully Linked with a TMT, flashing after 15 seconds of lost Link. (Note that this is the same icon used in Watch Mode to signify that the Daily Alarm is set On.)
- > TLBG with NI icon, if any after a NORM or FREE dive
- > Battery icon, if voltage is low

- A < 2 sec to access ALT 1 (ALT 2 if no dive yet)
- M < 2 sec to access NORM Menu
- M 2 sec to access Watch Mode
- S 2 sec to access Compass**
- L (on closure) to activate Backlight,

** Compass can only be accessed from Main.

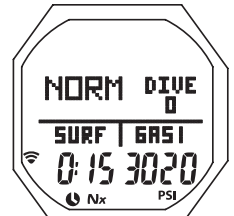

Fig. 26A - NORM SURF MAIN (no dive yet)

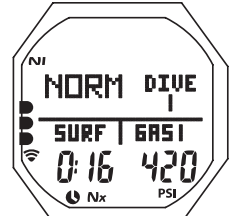

Fig. 26B - NORM SURF MAIN (after dive 1)

NORM SURF ALT 1, information includes (Fig. 27):

- > Max Depth with MAX and FT (or M) icons, 2 dashes (- -) if no previous dive
- > Elapsed Dive Time (hr:min) with graphic EDT, 3 dashes (- : - -) if no previous dive
- > Graphic LAST DIVE, indicating that data is from the dive previously conducted while in NORM mode

- A < 2 sec to access ALT 2
- 10 sec, revert to Main if A is not pressed
- L (on closure) to activate Backlight

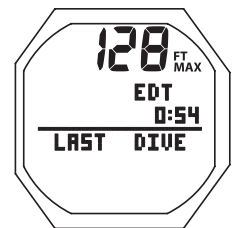

Fig. 27 - NORM SURF ALT 1 (Last dive's data)

NORM SURF ALT 2, information includes (Fig. 28):

- > Time of Day (hr: min sec) with A (or P)
- > Altitude graphic, if EL2 (to EL7), blank if Sea level
- > Temperature with ° icon and graphic F (or C)

- A < 2 sec to access ALT 3 (if set for Nitrox), or revert to Main (if set for Air)
- 5 sec, revert to Main if A is not pressed
- L (on closure) to activate Backlight



Fig. 28 - NORM SURF ALT 2

NORM SURF ALT 3, information includes (Fig. 29):

- > Graphic O2
- > Graphics FO2 and GAS 1 with FO2 Set Point
- > Nx icon
- > O2BG with O2 icon, current O2

- 5 sec or A < 2 sec, revert to Main
- L (on closure) to activate Backlight

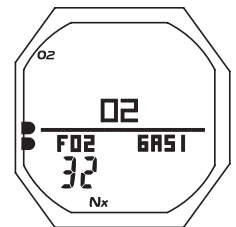

Fig. 29 - NORM SURF ALT 3

NORM MENU

- M (< 2 sec) - to access Menu, while viewing Surface Main
- A (< 2 sec) - to step down (forward) through selections
- M (< 2 sec) - to step up (backward) through selections
- S (< 2 sec) - to access selection indicated by Arrow icon (>)
- M (2 sec) any time - to revert to Surface Main
- 2 min (no button action) - will revert to Surface Main

FLY/DSAT TIME

Fly Time is a count down timer that begins counting down 10 minutes after surfacing from a dive from 23:50 to 0:00 (hr:min).

Dsat Time, also a count down timer, provides calculated time for tissue desaturation at sea level taking into consideration the Conservation Factor setting.

Dsat Time also begins counting down 10 minutes after surfacing from a dive, counting down from 23:50 (max) to 0:00 (hr:min).

When the Dsat count down reaches 0:00, which will generally occur prior to the Fly count down reaching 0:00, it will remain on the display until the Fly count down reaches 0:00.

- > Dsat is not displayed after a Gauge or Violation dive.
- > Desaturation requiring Times greater than 24 hours will display 23: - - .
- > In the event that Time to Desaturate still remains at the end of 24 hours, the added time will be zeroed.
- > When other screens are accessed, the Fly and Sat countdowns continue in the background.

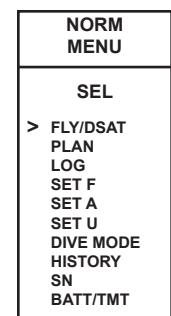

Fig. 29 - NORM SURF ALT 3

Fly/Dsat, information includes (Fig. 30A/B):

- > Time to Fly (hr:min), 0:00 if no dive yet, with graphic FLY
- > Time to Dsat (hr:min), 0:00 if no dive yet, with graphic DSAT
- > Time (clock) icon

- S < 2 sec, revert to Menu
- L (on closure) to activate Backlight

NORM PLAN MODE

No Deco Dive Times (NDLs) in NORM Plan Mode are based on the Algorithm selected (DSAT or PZ+) and only on the FO2 set for Gas 1. FO2 set for Gas 2 and 3 are not used.

NORM Menu >> Plan Lead-in >> PDPS

Plan Lead-in, information includes (Fig. 31A/B):

- > Graphic PLAN
- > Graphic FO2_1 (Gas 1)
- > Graphic Air or numeric % value (21 to 50), indicating the FO2 set for Gas 1
- > Graphic PO2 with PO2 Alarm value set (1.20 to 1.60), if Nitrox, blank if Air
- > Nx icon, if Nitrox

- S < 2 sec to access PDPS
- L (on closure) to activate Backlight

PDPS (Pre Dive Planning Sequence)

The PDPS displays Depths and allowable No Deco Dive Times. It will sequence through Depths from 30 to 190 FT (9 to 57 M), or the Max Depth that will allow theoretical No Deco Dive Time of at least 1 minute based upon the previous dive profiles in a series of repetitive dives and taking into account descent and ascent rates of 60 FPM (18 MPM).

When the Conservative Factor is set On, No Deco Dive times are reduced to the values of the next 3000 foot (915 meter) higher Altitude. Refer to tables in back.

PDPS, information includes (Fig. 32A/B):

- > Max Depth with MAX and FT (or M) icons, if Nitrox, blank if set for Air
- > Plan Depth value with graphic FT (or M)
- > Graphic NDC (or OTR) with Dive Time allowed (hr:min) with Time (clock) icon, no OTR if Air
- > Graphic PO2 with PO2 Alarm value set (1.20 to 1.60), if Nitrox, blank if set for Air
- > Nx icon, if Nitrox

- A (hold) to scroll upward through screens at a rate of 8 per second increasing planned Depth from 30 to 190 FT (9 to 57 M) in increments of 10 FT (3 M)
- A (< 2 sec) to step upward through screens one at a time
- M (< 2 sec) to step back through screens one at a time
- S (< 2 sec) to revert to the Plan Lead-in screen
- L (on closure) to activate Backlight

NORM/GAUG LOG MODE

Information from the latest 24 NORM and/or GAUG dives is stored for viewing. After exceeding 24 dives, the most recent dive is stored while the oldest is deleted.

- > Dives are numbered from 1 to 24 starting each time NORM (or GAUG) Dive Mode is activated. After the post dive 24 hour period has elapsed, the first dive of the next operation period is #1.
- > During the first 10 minutes after a dive (Transition Period), that dive's Log screens can be viewed. After 10 minutes, the Log screens for all dives stored can be viewed.
- > In the event that a dive's elapsed time (EDT) exceeds 9:59 (hr:min), the data at the 9:59 interval is recorded in the Log upon surfacing of the unit.

NORM Menu >> Log Preview >> Log Data 1 >> Log Data 2

Log Preview, information includes (Fig. 33):

- > Log Mode (book) icon
- > Graphic NO-D (or DECO or GAUG or VIOL)
- > Graphic DIVE and dive number (1 to 24, 0 if no dive yet).
- > Time dive began (hr:min) with Time (clock) icon and A (or P), and the graphic ALT if Alternate Time
- > Date, the dive was conducted
- > Nx icon, if Nitrox

- A (hold) to scroll upward through Preview screens at a rate of 8 per second
- A (< 2 sec) to step upward through screens one at a time
- M (< 2 sec) to step back through screens one at a time
- S (< 2 sec) to access the dive's Log Data 1 screen
- L (on closure) to activate Backlight



Fig. 30A - FLY/SAT (10 min after dive)



Fig. 30B - FLY/SAT (< 10 min after dive)

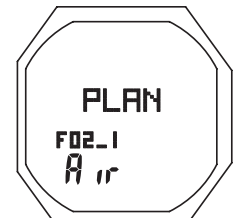

Fig. 31A - PLAN LEAD-IN (Gas 1 set for Air)

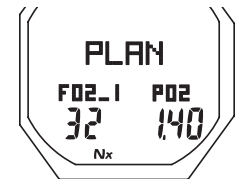

Fig. 31B - PLAN LEAD-IN (Gas 1 set for Nitrox)

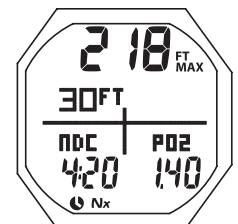

Fig. 32A - PDPS (nitrogen control)



Fig. 32B - PDPS (oxygen control)



Fig. 33 - LOG PREVIEW

Log Data 1, information includes (Fig. 34):

- > Log Mode (book) icon
- > Max Depth** with MAX and FT (or M) icons
- > Graphic DSAT (or PZ+), the NDL Basis (algorithm selected)
- > Graphic EDT with Dive Time (hr:min)
- > Graphic SURF and pre dive SI (hr:min), 0:00 if Dive # 1, 9:-- if > 9:59, with Time (clock) icon
- > Temperature (minimum that dive) with ° icon and graphic F (or C)
- > TLBG with the max segment flashing, others fixed up to end of dive accumulation. All segments flashing if a Violation. Blank if GAUG.
- > VARI, max Ascent Rate sustained for 4 sec
- > Nx icon, if Nitrox

** Max Depth for NORM dives is 330 FT (100 M), and for GAUG dives it is 660 FT (200 M).

- S (< 2 sec) to access the dive's Log Data 2 screen if Nitrox, or revert to the Preview screen if not
- L (on closure) to activate Backlight

Log Data 2 (Nitrox only), information includes (Fig. 35):

- > Log Mode (book) icon
- > Graphic GAS 1 (or 2 or 3), in use when dive ended
- > Graphic FO2 with FO2 Set Point (or graphic Air) for Gas in used when dive ended
- > Graphic PO2 with value of Max PO2 achieved
- > Nx icon
- > O2BG with O2 icon, accumulated when dive ended

- S (< 2 sec) to revert to the Preview screen
- L (on closure) to activate Backlight

SET F (FO2) MENU

S (< 2 sec) - to access Set F Menu while the selection Arrow icon (>) is next to Set F on the NORM Menu

- A (< 2 sec) - to step down (forward) through selections
- M (< 2 sec) - to step up (back) through selections
- S (< 2 sec) - to access selection indicated by Arrow icon (>)

The last setting saved is displayed next to each Menu item.

Refer to page 29 for an overview of FO2 settings and the 50% Default feature.

Set FO2 Gas 1, information includes (Fig. 36A/B):

- > Max Depth with MAX and FT (or M) icons, allowed for PO2 Alarm Set, blank if Air
- > Graphic GAS1
- > Graphic FO2 with FO2 Set Point value, flashing
- > Graphic PO2 with alarm value set
- > Nx icon, blank if Air

- A (hold) to scroll upward through Set Points at a rate of 8 per second from Air (default) to 21 through 50 (%) in increments of 1%.
 - > The scroll will stop when A is released, or pause at 32% if A is held depressed.
 - > Depress A, or keep it depressed, to resume the scroll from 32 through 50, then stop at Air (or 21%).
- A (< 2 sec) to step upward through Set Points one at a time
- M (< 2 sec) to step back through Set Points one at a time
- S (< 2 sec) to save the setting and revert to the Set F Menu

Gas 1 is the default gas on the surface prior to a new dive and 10 minutes after surfacing from dives.

Set FO2 Gas 2, information includes (Fig. 37):

- > Max Depth with MAX and FT (or M) icons, allowed for PO2 Alarm Set, blank if Air
- > Graphic GAS2
- > Graphic FO2 with FO2 Set Point value, flashing
- > Graphic PO2 with alarm value set
- > Nx icon, blank if Air

- A (hold) to scroll upward through Set Points at a rate of 8 per second from Air** to 21 through 100 (%) in increments of 1%.
 - > The scroll will start at the FO2 Gas 1 Set Point** and stop when A is released, or pause at 50 then again at 80% if A is held depressed.
 - > Depress A, or keep it depressed, to resume the scroll up through 100, then stop at the Gas 1 Set Point.
- A (< 2 sec) to step upward through Set Points one at a time
- M (< 2 sec) to step back through Set Points one at a time
- S (< 2 sec) to save the setting and revert to the Set F Menu

**Gas 2 cannot be set at a value less than that set for Gas 1.

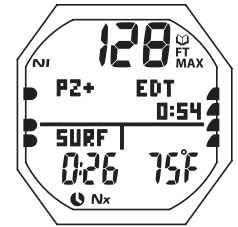

Fig. 34 - LOG DATA 1

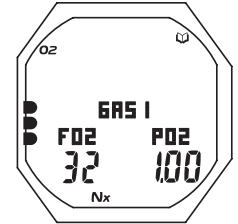

Fig. 35 - LOG DATA 2

Set F Menu	
> FO2 1	AIR
FO2 2	32
FO2 3	100
DFLT	ON



Fig. 36A - SET FO2 GAS 1

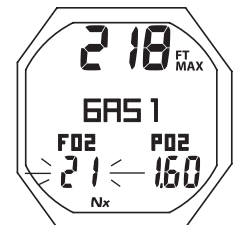

Fig. 36B - SET FO2 GAS 1



Fig. 37 - SET FO2 GAS 2

Set FO2 Gas 3, information includes (Fig. 38):

- > Max Depth with MAX and FT (or M) icons, allowed for PO2 Alarm Set, blank if Air
- > Graphic GAS2
- > Graphic FO2 with FO2 Set Point value, flashing
- > Graphic PO2 with alarm value set
- > Nx icon, blank if Air

- A (hold) to scroll upward through Set Points at a rate of 8 per second from Air** to 21 through 100 (%) in increments of 1%.
 - > The scroll will start at the FO2 Gas 2 Set Point** and stop when A is released, or pause at 50 then again at 80% if A is held depressed.
 - > Depress A, or keep it depressed, to resume the scroll up through 100, then stop at the Gas 2 Set Point.
- A (< 2 sec) to step upward through Set Points one at a time
- M (< 2 sec) to step back through Set Points one at a time
- S (< 2 sec) to save the setting and revert to the Set F Menu

**Gas 3 cannot be set at a value less than that set for Gas 2.

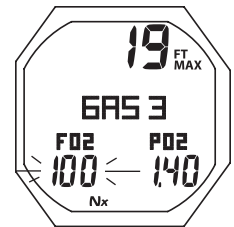

Fig. 38 - SET FO2 GAS 3

Set FO2 Default, information includes (Fig. 39):

- > Graphics DEFAULT and 50
- > Set Point graphics ON and OFF; Arrow (>) icon next to the one previously saved flashing
- > Nx icon, blank if Air

- A (< 2 sec) to toggle Set Points
- S (< 2 sec) to save the setting and revert to the Set F Menu

Turning the FO2 Default feature On controls FO2 Nitrox settings regardless of Set Points selected for Gases 1, 2, or 3.

Refer to page 29 for an overview of the 50% Default feature.

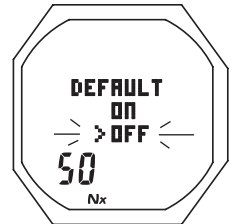

Fig. 39 - SET FO2 DEFAULT

SET A (ALARMS) MENU

S (< 2 sec) - to access Set A Menu while the selection Arrow icon (>) is next to Set A on the NORM (or GAUG) Menu

- A (< 2 sec) - to step down (forward) through selections
- M (< 2 sec) - to step up (back) through selections
- S (< 2 sec) - to access selection indicated by Arrow icon (>)

Refer to page 9 for additional information relating to Alarms.

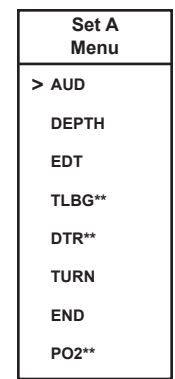

Set Audible Alarm, information includes (Fig. 40):

- > Graphic AUDIBLE
- > Set Point graphics ON and OFF; Arrow (>) icon next to the one previously saved flashing

- A (< 2 sec) to toggle Set Points
- S (< 2 sec) to save the setting and revert to the Set A Menu

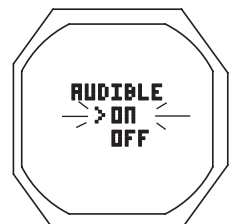

Fig. 40 - SET AUDIBLE AL

Set Depth Alarm, information includes (Fig. 41):

- > Graphic DEPTH AL
- > Graphic OFF flashing, or Depth value flashing with MAX and FT (or M) icons

- A (hold) to scroll upward through Set Points at a rate of 8 per second from 30 to 330 FT (10 to 100 M) in increments of 10 FT (1 M)
- A (< 2 sec) to step upward through Set Points one at a time
- M (< 2 sec) to step back through Set Points one at a time
- S (< 2 sec) to save the setting and revert to the Set A Menu

There is a separate alarm associated with exceeding the MOD (max operating depth) which is a violation described later.

FREE mode has separate Depth Alarms that are not affected by this setting.

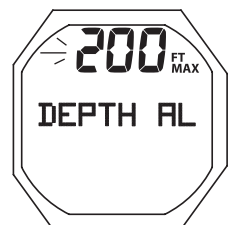

Fig. 41 - SET DEPTH AL

Set EDT Alarm, information includes (Fig. 42):

- > Graphic EDT AL with MAX icon
- > Elapsed Dive Time value (hr:min) flashing with MAX and Time (clock) icons

- A (hold) to scroll upward through Set Points at a rate of 8 per second from 0:10 to 3:00 (hr:min) in increments of :05 (:min)
- A (< 2 sec) to step upward through Set Points one at a time
- M (< 2 sec) to step back through Set Points one at a time
- S (< 2 sec) to save the setting and revert to the Set A Menu

FREE Mode has a separate EDT Alarm.

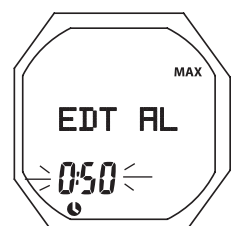

Fig. 42 - SET EDT AL

Set TLBG Alarm, information includes (Fig. 43):

- > Graphic TLBG AL
- > Depth value flashing with MAX and FT (or M) icons
- A (< 2 sec) to step upward through Set Points from 1 to 5 segments one at a time
- M (< 2 sec) to step back through Set Points one at a time
- S (< 2 sec) to save the setting and revert to the Set A Menu

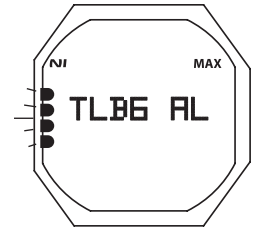

Fig. 43 - SET TLBG AL

FREE Mode has a separate TLBG Alarm.

Set DTR Alarm, information includes (Fig. 44):

- > Graphic DTR AL
- > Dive Time Remaining value (hr:min) flashing with Time (clock) icon
- A (hold) to scroll upward through Set Points at a rate of 8 per second from 0:00 to 0:20 (hr:min) in increments of :01 (:min)
- A (< 2 sec) to step upward through Set Points one at a time
- M (< 2 sec) to step back through Set Points one at a time
- S (< 2 sec) to save the setting and revert to the Set A Menu

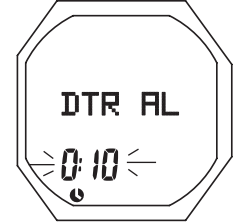

Fig. 44 - SET DTR AL

Set Turn Press Alarm**, information includes (Fig. 45):

- > Graphic TURN AL
- > Graphic OFF or Pressure value flashing with PSI (or BAR) icon
- A (hold) to scroll upward through Set Points at a rate of 8 per second from OFF to 1000 to 3000 PSI (70 to 205 BAR) in increments of 250 PSI (5 BAR)
- A (< 2 sec) to step upward through Set Points one at a time
- M (< 2 sec) to step back through Set Points one at a time
- S (< 2 sec) to save the setting and revert to the Set A Menu

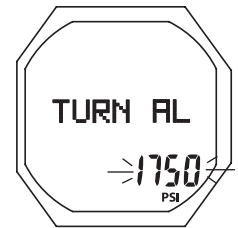

Fig. 45 - SET TURN AL

**Turn Pressure only applies to TMT 1 (Transmitter 1).

Set End Press Alarm**, information includes (Fig. 46):

- > Graphic END AL
- > Pressure value flashing with PSI (or BAR) icon
- A (hold) to scroll upward through Set Points at a rate of 8 per second from 300 to 1500 PSI (20 to 105 BAR) in increments of 100 PSI (5 BAR)
- A (< 2 sec) to step upward through Set Points one at a time
- M (< 2 sec) to step back through Set Points one at a time
- S (< 2 sec) to save the setting and revert to the Set A Menu

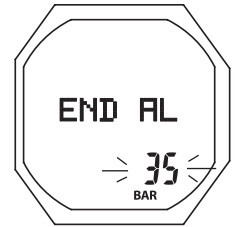

Fig. 46 - SET END AL

**End Pressure applies to the TMT (Transmitter) in use.

Set PO2 Alarm, information includes (Fig. 47):

- > Graphic PO2 AL with MAX and Nx icons
- > Graphic ATA (atmospheres absolute) with value flashing
- A (< 2 sec) to step upward through Set Points from 1.20 to 1.60 one at a time
- M (< 2 sec) to step back through Set Points one at a time
- S (< 2 sec) to save the setting and revert to the Set A Menu

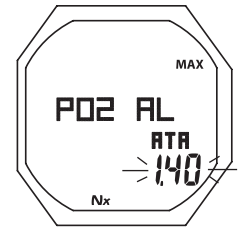

Fig. 47 - SET PO2 AL

SET U (UTILITIES) MENU

S (< 2 sec) - to access Set U Menu while the selection Arrow icon (>) is next to Set U on the NORM (or GAUG) Menu

- A (< 2 sec) - to step down (forward) through selections
- M (< 2 sec) - to step up (back) through selections
- S (< 2 sec) - to access selection indicated by Arrow icon (>)

Selections for Wet Activation, Units, NDL basis, Conserv, and Glo Dura also apply to FREE Dive Mode.
> To change any of these items while in FREE mode, use the Set U selection in the NORM Menu.

Set Wet Activation, information includes (Fig. 48):

- > Graphic WET ACTIV
- > Set Point graphics ON and OFF; Arrow (>) icon next to the one previously saved flashing
- A (< 2 sec) to toggle Set Points
- S (< 2 sec) to save the setting and revert to the Set U Menu

Set U Menu
> WET ACTIV
UNITS
DEEP STOP**
SAFE STOP**
NDL BASIS**
CONSERV**
GLO DURA
SAMPLING
TMT

** NORM only

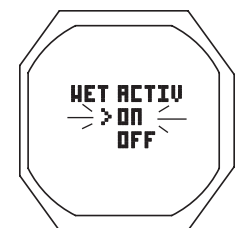

Fig. 48 - SET WET ACTIV

Set Units, information includes (Fig. 49):

- > Graphic UNITS
- > Set Point graphics IMPERIAL and METRIC; Arrow (>) icon next to the one previously saved flashing
- A (< 2 sec) to toggle Set Points
- S (< 2 sec) to save the setting and revert to the Set U Menu

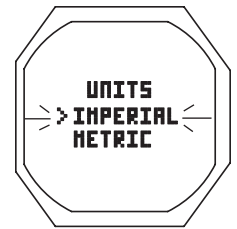

Fig. 49 - SET UNITS

Set Deep Stop, information includes (Fig. 50):

- > Graphic DEEP STOP
- > Set Point graphics ON and OFF; Arrow (>) icon next to the one previously saved flashing
- A (< 2 sec) to toggle Set Points
- S (< 2 sec) to save the setting and revert to the Set U Menu

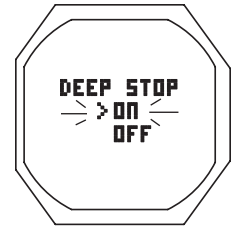

Fig. 50 - SET DEEP STOP

Deep Stop, which applies only to NORM No Deco dives, is described on page 33.

Set Safety Stop, information includes (Fig. 51A):

- > Stop Time Set Point graphics OFF, 3 MIN, and 5 MIN; Arrow (>) icon next to the one previously saved flashing
- A (< 2 sec) to step upward through Set Points one at a time
- M (< 2 sec) to step back through Set Points one at a time
- S (< 2 sec) to save the Stop Time setting and display the Set Safety Stop Depth screen

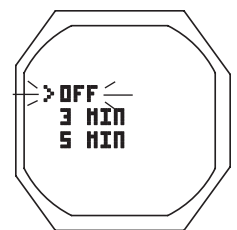

Fig. 51A - SET SAFETY STOP TIME

Set Safety Stop Depth, information includes (Fig. 51B):

- > Stop Depth Set Point graphics 10 FT, 15 FT, and 20 FT (or 3 M, 4 M, 5 M, and 6 M); Arrow (>) icon next to the one previously saved flashing
- A (< 2 sec) to step upward through Set Points one at a time
- M (< 2 sec) to step back through Set Points one at a time
- S (< 2 sec) to save the Stop Depth setting and revert to the Set U Menu

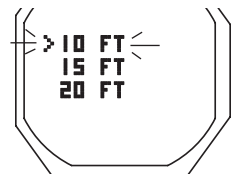

Fig. 51B - SET SAFETY STOP DEPTH

Safety Stop, which applies only to NORM No Deco dives, is described on page 34.

Set NDL Basis, information includes (Fig. 52):

- > Graphic NDL BASIS
- > Set Point graphics PZ+ and DSAT; Arrow (>) icon next to the one previously saved flashing
- A (< 2 sec) to toggle Set Points
- S (< 2 sec) to save the setting and revert to the Set U Menu



Fig. 52 - SET NDL BASIS

This feature, which allows selection of the algorithm to be used for nitrogen and oxygen calculations for Plan and DTR values, is described on page 29.

Set Conserv, information includes (Fig. 53):

- > Graphic CONSERV
- > Set Point graphics ON and OFF; Arrow (>) icon next to the one previously saved flashing
- A (< 2 sec) to toggle Set Points
- S (< 2 sec) to save the setting and revert to the Set U Menu

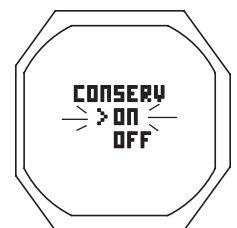

Fig. 53 - SET CONSERVATIVE FACTOR

When CONSERV (Conservative Factor) is set On, NDLs are reduced to values equivalent to those that would be available at the next higher 3000 foot (915 meter) Altitude. Refer to the charts on page 63.

Set Glo Dura, information includes (Fig. 54):

- > Graphics GLO and DURATION
- > Set Point 0 (or 5, 10, 30, 60) flashing with graphic SEC
- A (< 2 sec) to step upward through Set Points one at a time
- M (< 2 sec) to step back through Set Points one at a time
- S (< 2 sec) to save the setting and revert to the Set U Menu



Fig. 54 - SET BACKLIGHT DURATION

Glo Dura (Backlight Duration) is the time the backlight will remain On after L is released.

Set Sampling, information includes (Fig. 55):

- > Set Point graphics 2 SEC, 15 SEC, 30 SEC; Arrow (>) icon next to the one previously saved flashing
- A (< 2 sec) to step upward through Set Points one at a time
- M (< 2 sec) to step back through Set Points one at a time
- S (< 2 sec) to save the setting and revert to the Set U Menu

Sampling is the Rate at which data is sampled and stored for download to the associated PC Interface program described on page 58.

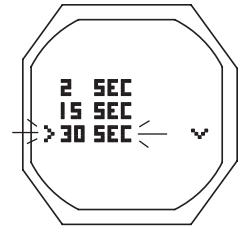

Fig. 55 - SET SAMPLING RATE

SET TMT MENU, information includes (Fig. 56):

S (< 2 sec) - to access Set TMT Menu while the selection Arrow icon (>) is next to Set TMT on the NORM (or GAUG) Menu

- > Graphic SET
- > Graphic selections TMT 1, TMT 2, and TMT 3 with last setting saved (ON or OFF)

- A (< 2 sec) - to step down (forward) through selections
- M (< 2 sec) - to step up (back) through selections
- S (< 2 sec) - to access selection indicated by Arrow icon (>)

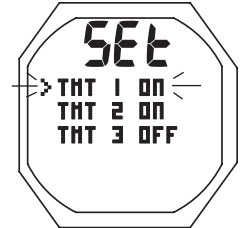

Fig. 56 - SET TMT MENU

Set TMT 1, information includes (Fig. 57):

- > Graphic TMT 1
- > Set Point graphics ON and OFF; Arrow (>) icon next to the one previously saved flashing

- A (< 2 sec) to toggle Set Points
- S (< 2 sec) to save the setting
- > If OFF, the receiver is disabled, Set TMT 2 and 3 are bypassed, and operation reverts to the Set U Menu.
- > If ON, the receiver is enabled and the Set TMT 1 SN screen is displayed.

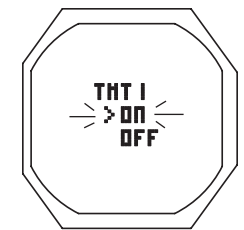

Fig. 57 - SET TMT 1

Set TMT 1 SN, information includes (Fig. 58):

- > Graphics TMT 1 and SERIAL NO
- > Numerical code (6 digits), 1st (left) flashing

- A (< 2 sec) to step upward one at a time
- M (< 2 sec) to step back one at a time
- S (< 2 sec) to save the 1st digit and flash the 2nd
- Repeat A and M action to set other digits
- S (< 2 sec) after last to save SN and revert to TMT Menu



Fig. 58 - SET TMT 1 SN

>> Set TMT 2 & 3 are similar to Set TMT 1.

SELECT DIVE MODE

S (< 2 sec) - to access Set Dive Mode while the selection Arrow icon (>) is next to it on the NORM Menu

Set Dive Mode, information includes (Fig. 59):

- > Graphics SEL and DIVE MODE
- > Set Point graphics GAUG and FREE; Arrow (>) icon next to GAUG

- A (< 2 sec) to toggle between the selections
- S (< 2 sec) to save the selection and access that mode's Surface Main screen



Fig. 59 - SELECT DIVE MODE

NORM/GAUG HISTORY MODE

S (< 2 sec) - to access History 1 while the selection Arrow icon (>) is next to History on the NORM (or GAUG) Menu

History 1, information includes (Fig. 60):

- > Graphic HIST
- > Total number dives ever recorded (up to 9999) with graphic DIVES, 0 if no dive yet
- > Total hours of EDT (dive time) ever recorded with graphic Hour and Time (clock) icon, 0 if < 1 hour

- S (< 2 sec) to access History 2



Fig. 60 - HISTORY 1

History 2, information includes (Fig. 61):

- > Max Depth ever (up to 660 FT/200 M) with MAX and FT (or M) icons
- > Graphic HIST
- > Graphic SEA, or EL2 to EL7, highest Altitude at which a dive was conducted
- > Temperature with ° icon and graphic F (or C), lowest recorded during any dive

- S (< 2 sec) to revert to NORM (or GAUG) Menu



Fig. 61 - HISTORY 2

SERIAL NUMBER

S (< 2 sec) - to access while the selection Arrow icon (>) is next to it on the NORM Menu

Serial Number, information includes (Fig. 62):

- > Graphic SN
- > OC1's factory programmed SN
- > Graphic r1A (or higher), indicating the revision level of the Firmware (OC1's operating software); followed by 01 (or higher), indicating the revision level of the Display

- S (< 2 sec) to revert to the NORM (or GAUG) Menu



Fig. 62 - SERIAL NUMBER

BATTERY/TMT STATUS

S (< 2 sec) - to access while the selection Arrow icon (>) is next to it on the NORM (or GAUG) Menu

Access to this selection activates the OC1's Receiver, then after 2 seconds, starts an automatic scroll displaying a sequence of Status screens >>

- > OC1 Battery Status for 3 sec
- > TMT 1 Status for 3 sec
- > TMT 2 Status for 3 sec
- > TMT 3 Status for 3 sec
- > revert to NORM (or GAUG) Menu



Fig. 63 - OC1 STATUS

OC1 Battery Status, information includes (Fig. 63):

- > Graphics OC1 and BATT
- > Graphic GOOD (=> 2.75 v) or LO (< 2.75 v)
- > Battery icon, if LO, flashing (< 2.50 v)

TMT Status, information includes (Fig. 64A):

- > Graphics TMT1 (or 2 or 3) and BATT
- > Graphic GOOD (if linked and => 2.75 v) or LO (< 2.75 v)
- > Tank Pressure with PSI (or BAR) and Link icons, if the TMT is active and reporting



Fig. 64A - TMT STATUS

TMT Status (not reporting), information includes (Fig. 64B):

- > Graphic TMT1 (or 2 or 3)
- > Graphic NOT AVAIL

This screen appears when the OC1's receiver is not receiving a signal from a TMT, or the TMT is set Off.



Fig. 64B - TMT NOT REPORTING

DIVE MODE FEATURES

NORM DIVE MODE STRUCTURE

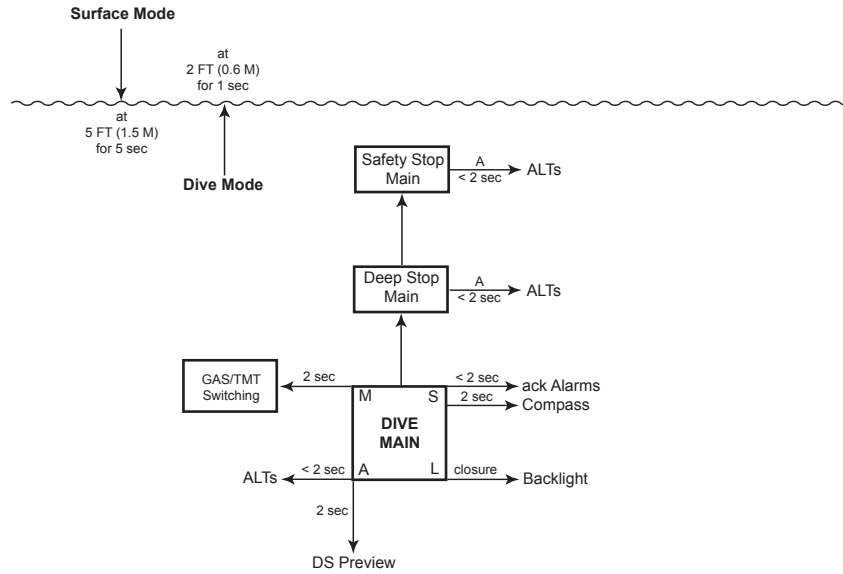

TRANSMITTER SIGNAL RECEPTION GUIDE

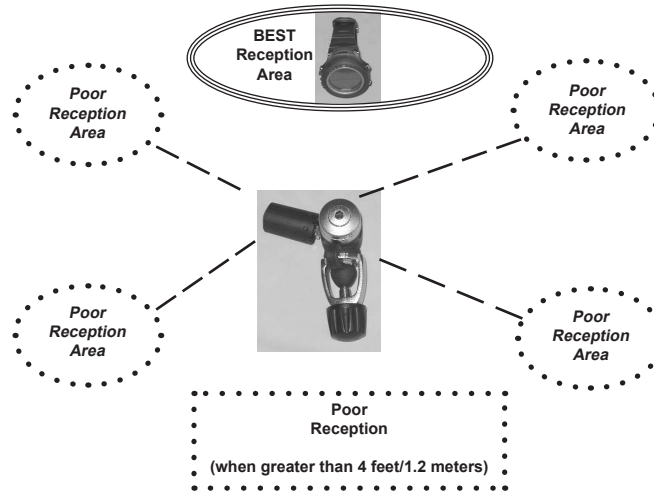

PROXIMITY OF THE TMTs (Transmitters) AND OC1

The TMTs emit low frequency signals that radiate out in semicircular patterns parallel to the length dimension of the TMT. A coiled antenna inside the OC1 receives the signals when it is positioned within a zone parallel to or at a 45 degree angle to the TMT as illustrated.

The OC1 cannot effectively receive a signal when it is held out to the sides of the TMT or held at distances greater than 4 feet (1.2 meters) in front of the TMT. Best reception is achieved when the OC1 is within 3 feet (1 meter) of the TMT.

When installed into the high pressure ports of the Regulator First Stages, the TMTs must be positioned so that they face horizontally outward from the Tank Valves.

Link Interruption Underwater

During a dive, you may at times move the OC1 out of the signal pattern of the TMT, resulting in a temporary loss of the Link signal. The Link will be restored within 4 seconds after the OC1 is moved back into its correct position.

An interruption may also occur while the OC1 is within 3 feet (1 meter) of a running DPV. The Link will be restored within 4 seconds after the OC1 is moved out of that area.

A temporary interruption may also occur shortly after a Strobe flashes. The Link will be restored within 4 seconds.

If the Link is not restored within 15 seconds, the Audible will sound, and the Pressure value and Link icon will flash (Fig. 65).

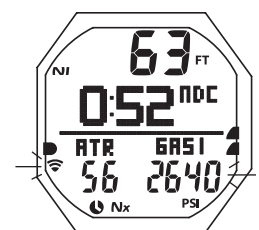

Fig. 65 - LOSS OF LINK

WET ACTIVATION

The OC1 is configured with contacts that will automatically activate Dive Mode when the space between the contacts is bridged by a conductive material (immersed in water) and it senses a Depth of 5 FT (1.5 M).

The contacts are the metal pins of the PC Interface Data Port and the metal housing.

When Wet Activation is set Off, the OC1 will not enter Dive Mode while in Watch Mode unless a dive has already been conducted and it is a repetitive dive.

BACKLIGHT

Press L (Light) button to activate (on closure).

- On for L depression time plus the Duration set (0, 5, 10, 30, or 60 sec).
- Press L while On to reset timer and keep On for full Duration.
- Shuts Off if L is depressed for more than 10 sec.

- > Extensive use of the Backlight reduces Battery life.
- > The Backlight does not operate during a Low OC1 Battery condition (< 2.75 v), or when the Oceanlog PC Interface cable is connected to the OC1.

BAR GRAPHS

The OC1 features 2 bar graphs, one on each side of the LCD.

- > The one on the left is dual function. It represents either Nitrogen loading or Oxygen accumulation. The icons NI and O2 identify which is displayed at that time.
- > Throughout this manual, they are referred to as the NIBG or TLBG (Tissue Loading Bar Graph) and O2BG.
- > Regardless of which parameter the Bar Graph is representing at the time, nitrogen and oxygen calculations will continue to be performed in the background.
- > The one on the right represents ascent rate. It is referred to as the VARI (Variable Ascent Rate Indicator).

TLBG

The TLBG represents your relative No Deco (Fig. 66Aa) or Deco status (Fig. 66Ba). The lower 4 segments represent No Deco status and the fifth at the top indicates a Deco condition. As your Depth and Elapsed Dive Time increase segments add, and as you ascend segments recede, indicating that additional no deco time is available.

The OC1 monitors 12 different nitrogen compartments simultaneously and the TLBG displays the one that is in control of your dive at any given time.

O2BG

When operating in NORM Nitrox mode, the O2BG (Fig. 67a) will be displayed on an Alternate screen. It represents oxygen exposure, either oxygen accumulated during a dive or over a period of 24 hours.

As your oxygen exposure increases, segments will add to the O2BG, and as it decreases, they will begin to recede, indicating that additional exposure is allowed for that dive and 24 hour period.

The OC1 will store O2 calculations for up to 10 dives conducted during a 24 hour period. If the limit for O2 is reached (100% = 300 OTU), all 5 segments of the O2BG will be displayed on the Main dive screen in place of the TLBG (Fig. 68a).

After surfacing, Plan Mode will not be available until the O2BG recedes into the normal zone (4 segments).

VARI

The VARI (Fig. 69a) provides a visual representation of ascent speed (i.e., an ascent speedometer).

The segments represent two sets of speeds which change at a reference depth of 60 FT (18 M). Refer to the chart.

When ascent is too fast, all segments will be displayed flashing (Fig. 70) until ascent is slowed.

⚠ WARNING: At depths greater than 60 FT (18 M), ascent rates should not exceed 60 FPM (18 MPM). At depths of 60 FT (18 M) and shallower, ascent rates should not exceed 30 FPM (9 MPM).

Deeper than 60 FT (18 M)			60 FT (18 M) & Shallower		
Segments	Ascent Rate		Segments	Ascent Rate	
	FPM	MPM		FPM	MPM
0	0 - 20	0 - 6	0	0 - 10	0 - 3
1	21 - 30	6.1 - 9	1	11 - 15	3.1 - 4.5
2	31 - 40	9.1 - 12	2	16 - 20	4.6 - 6
3	41 - 50	12.1 - 15	3	21 - 25	6.1 - 7.5
4	51 - 60	15.1 - 18	4	26 - 30	7.6 - 9
5	60 +	18 +	5	30 +	9 +

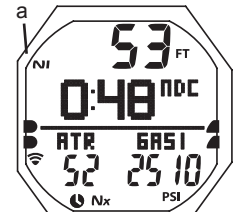

Fig. 66A - NO DECO

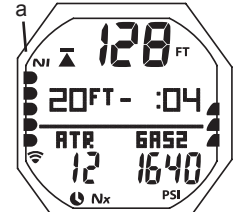

Fig. 66B - DECO

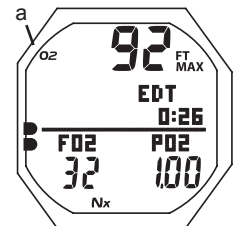

Fig. 67 - NO DECO ALT

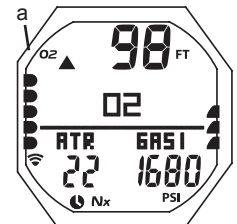

Fig. 68 - DIVE MAIN (High O2)

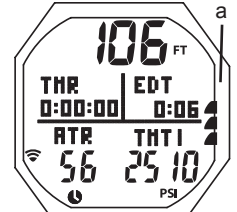

Fig. 69 - GAUG DIVE



Fig. 70 - DIVE MAIN (Ascent Too Fast)

ALGORITHM (NDL Basis)

The OC1 is configured with 2 algorithms which allows you to choose which set of NDLs (No Deco Limits) will be used for Ni/O₂ calculations and displays relating to Plan and DTR (Dive Time Remaining).

You can select DSAT or PZ+ as the NDL Basis. The selection will lock in for 24 hours after the last dive.

DSAT has been the standard used by Oceanic in all of its dive computers until this time. It features NDLs that are based on exposures and test data which also formed validation for the PADI RDP. It imposes restrictions for repetitive Deco dives, considered more risky.

PZ+ (Pelagic Z+) performance is based on Buhlmann ZHL-16c. It features NDLs that are considerably more conservative especially at shallower depths.

To create even greater margins of safety with respect to decompression, a Conservative Factor as well as No Deco Deep and Safety Stops can be included for No Deco dives.

Refer to -

- page 23, for setting Deep Stop
- page 23, for setting Safety Stop
- page 23, for setting NDL Basis
- page 23, for setting Conservative Factor
- page 63, for PZ+ and DSAT NDL charts

CONSERVATIVE FACTOR (CF)

When the CF is set On, the NDLs which are based on the algorithm selected and used for Ni/O₂ calculations and displays relating to Plan and DTR, will be reduced to the values available at the altitude level that is 3,000 feet (915 meters) higher.

DEEP STOP (DS)

When the DS selection is set On, it will trigger during NORM No Deco dives when you descend to 80 FT (24 M) and calculate (and continually update) a Stop Depth equal to 1/2 the Max Depth.

While 10 FT (3 M) deeper than the calculated DS, you will be able to access a DS Preview screen (A 2 sec) that will display the current DS Stop Depth/Time (fixed at 2 min) for 5 seconds then return to the Main.

Upon initial ascent to within 10 FT (3 M) below the calculated Stop Depth, a DS screen displaying a Stop Depth at 1/2 the Max Depth will appear with a Countdown Timer beginning at 2:00 (min:sec) and counting down to 0:00.

- > If you descend 10 FT (3 M) below, or ascend 10 FT (3 M) above, the calculated Stop Depth for 10 seconds during the countdown, the No Deco Main will replace the DS Main display and the DS feature will be disabled for the remainder of that dive. There is no Penalty if the DS is ignored.
- > In the event that you enter Deco, exceeds 190 FT (57 M), or a High O₂ condition (=> 80%) occurs, the DS will be disabled for the remainder of that dive.
- > The DS is disabled during a High PO₂ Alarm condition (=> Set Point).

SAFETY STOP (SS)

Upon ascending to 5 FT (1.5 M) below the SS Depth set on any NORM No Deco dive in which Depth exceeded 30 FT (9 M), the Audible will sound and a SS at the Depth set will be displayed with a countdown beginning at the Safety Stop Time set and counting down to 0:00 (min:sec). If the SS Time was set for Off, the display will not appear.

In the event that you descend below 30 FT (9 M) during the countdown, or the countdown reaches 0:00, the No Deco Main will replace the SS Main screen which will reappear upon ascent to 5 FT (1.5 M) below the SS Depth set.

In the event that you enter Deco, complete the Deco obligation, and then descend below 30 FT (9 M); the SS Main will appear upon ascent to 5 FT (1.5 M) below the SS Depth.

There is no Penalty if you surface prior to completing the Safety Stop or ignore it.

OVERVIEW OF FO₂ SETTINGS AND 50% DEFAULT

Refer to page 20 for Set FO₂.

Setting FO₂ for NORM Nitrox Dives

For each numeric value of FO₂ displayed on set screens, the MOD (Max Operating Depth) that can be achieved with the PO₂ Alarm set will be displayed.

When the FO₂ 50% Default is set On and FO₂ Gas 1 is set for a numerical value, 10 minutes on the surface after that dive the FO₂ Gas 1 will be displayed as 50 and further dives will be calculated based on 50% O₂ for oxygen calculations and 21% O₂ for Nitrogen calculations (79% Nitrogen) unless FO₂ Gas 1 is set before the dive.

FO₂ Gas 1 will continue to reset to the FO₂ 50% Default after subsequent repetitive dives until 24 hours elapse after the last dive, or the FO₂ 50% Default is set Off.

When the FO₂ 50% Default is set Off, the OC1 will remain set at the last FO₂ Gas 1 Set Point for that period of activation.

FO2 set to Air

The default FO2 Gas 1 each new dive period will be Air. When FO2 Gas 1 is set for Air, calculations are the same as when FO2 is set for 21%. When FO2 Gas 1 is set for Air, it will remain set for Air until set for a numerical FO2 value (21 to 50%).

When FO2 Gas 1 is set for Air, the O2BG will not be displayed at any time during the dive, on the surface, or during the PDPS. PO2 will not be displayed during the dive.

MOD will not be displayed on the FO2 set screen when Air is displayed.

Internally, the OC1 will keep track of the oxygen loading so that if FO2 for Gas 1 is subsequently set for Nitrox, the oxygen loading for previous Air dives will be accounted for in the next Nitrox dive (during that dive period and series of repetitive dives).

FO2 set for Nitrox

When FO2 for any Gas is set for a numerical value, the dive is considered Nitrox and the Nx icon will be displayed.

Once FO2 Gas 1 is set for a numerical value (21 to 50%), the Air option is disabled until 24 hours elapse after the last dive.

- The Air option will not be displayed in Set FO2 for Gas 1 until a full 24 hour Surface Interval has elapsed.
- If the FO2 50% Default is set Off, FO2 remains at the values set until changed. If the Default is set On, all FO2 values default to 50%.
- The OC1 is programmed to prevent FO2 Gas 2 and 3 from being set at values lower than the FO2 Set Point for Gas 1. Gas 2 and Gas 3 require Set Points equal to/higher than Gas 1 and Gas 2, respectively.

DIVE TIME REMAINING (DTR)

The OC1 constantly monitors No Deco status, O2 Accumulation, and Air Time Remaining (when TMTs are used), and will display whichever Time is the least amount available as DTR on the No Deco Dive Main screen (Fig. 71). The graphic NDC, OTR, or ATR will identify the Time displayed. If ATR is DTR, it will not be displayed at the lower/left.

No Deco DTR (NDC)

NDC is the maximum amount of time that you can stay at your present Depth before entering Deco. It is calculated based on the amount of Nitrogen absorbed by hypothetical tissue compartments. The rates each of these compartments absorb and release Nitrogen is mathematically modeled and compared against a maximum allowable Nitrogen level.

Whichever one is closest to this maximum level is the controlling compartment for that Depth. Its resulting value will be displayed NDC time (Fig. 71a) and graphically as the TLBG (Fig. 71b).

As you ascend, the TLBG segments will recede as control shifts to slower compartments. This is a feature of the Decompression Model that is the basis for Multilevel Diving, one of the most important advantages that Oceanic dive computers offer.

O2 DTR (OTR)

When the OC1 is set for Nitrox operation, O2 accumulation during a dive, or 24 hour period, is displayed as the O2BG on an ALT screen (Fig. 72a). As time remaining before reaching the O2 Exposure Limit decreases, segments are added to the O2BG.

When the amount of time remaining before reaching the O2 Limit becomes less than the NDC, calculations for that Depth will be controlled by O2 and OTR will be displayed as DTR on the Main.

Air Time Remaining (ATR)

The OC1 calculates ATR using a patented algorithm that is based on a diver's individual Air Consumption Rate and Current Depth.

Tank Pressure is measured once each second and an average rate of Consumption is calculated over a 90 second period. This Rate of Consumption is then used in conjunction with a knowledge of the Depth dependence to predict the Air required for the diver to make a safe controlled Ascent including the No Deco Deep and Safety Stops and any required Deco Stops.

Air Consumption and Depth are continuously monitored and ATR reflects any change in circumstances. For example, when a buddy starts breathing from your Octopus or you suddenly find yourself swimming against a strong current and begin breathing more rapidly, the OC1 will recognize the change and adjust ATR accordingly.

ATR is the time you can remain at the present Depth and still safely surface with the Tank Pressure reserve that you selected during setup (End Pressure Alarm Setting).

ATR is displayed on the NORM No Deco and GAUG Main, and Deco ALT screen, when <= 60 minutes (Fig. 73a).

ATR Alarm

When ATR decreases to 5 minutes, the Audible will sound and the ATR Time digits will flash (Fig. 74). If it decreases to 0, the Audible will sound again. The digits will continue to flash until ATR becomes greater than 5 minutes.

You should initiate a controlled Ascent while monitoring Tank Pressure. However, there is no reason to panic, the OC1 is allowed for the Air necessary for a safe Ascent including the No Deco Deep and Safety Stops, if set On, and any Deco Stops required.

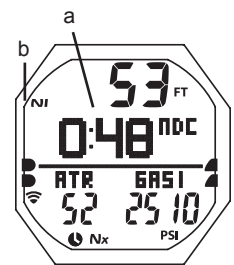

Fig. 71 -NO DECO MAIN

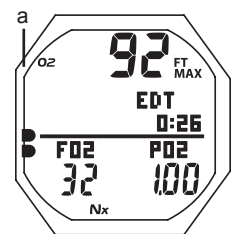

Fig. 72 -NO DECO ALT 1

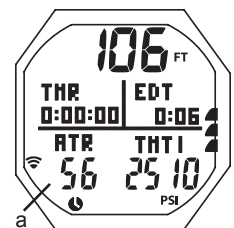

Fig. 73 -GAUG DIVE MAIN

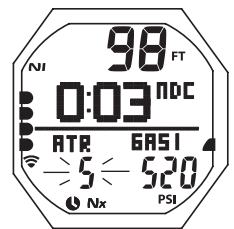

Fig. 74 -ATR ALARM

ERROR (RESET DURING A DIVE)

If for any reason, the OC1 shuts Off then turns On again during any Dive, the graphic ERR (Error) will be displayed with the Up Arrow icon and current Depth with FT (or M) icon (Fig. 75A).

If this occurs, it is highly recommended that you terminate the dive and begin a safe ascent to the surface.

Upon surfacing, ERR will be displayed for 5 seconds (Fig. 75B) and operation will revert to Watch Mode.

Any time thereafter, when access to Dive Computer Operating Mode is attempted from Watch Mode, only the graphic ERR will be displayed and operation will revert to Watch Mode. No Dive Computer modes/screens will be accessible.

If this occurs, the OC1 must be returned to the factory for evaluation/service prior to any further use for diving activities.



Fig. 75A -ERROR
(during dive)

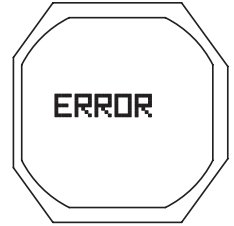

Fig. 75B -ERROR
(after surfacing)

NORM

DIVE MODES

NO DECO MAIN, information includes (Fig. 76) -

- > Current Depth with FT (or M) icon
- > DTR (hr:min) with graphic NDC (or OTR or AIR), whichever is less at the time
- > ATR (min) when 60 minutes or less with graphic ATR and Time (clock) icon, blank if no TMT or ATR is DTR
- > Graphic GAS1 (or 2 or 3), one in use
- > Pressure with PSI (or BAR) and Link icons, if Rcvr and TMT are active, flashing when Link is lost
- > Nx icon, if any Gas is Nitrox
- > TLBG with NI icon
- > VARI while ascending

- A (< 2 sec) to access ALTs
- A (2 sec) to access Deep Stop Preview**, if triggered
- M (2 sec) to access Gas Switching**
- S (< 2 sec) to acknowledge alarms
- S (2 sec) to access Compass**
- L (closure) to activate Backlight

**These items can only be accessed while viewing the Main.

No Deco Alt 1, information includes (Fig. 77) -

- > Max Depth with MAX and FT (or M) icons
- > Graphic EDT with Elapsed Dive Time (hr:min)
- > Graphic FO2 with Set Point for Gas in use
- > Graphic PO2 with current value (ATA), if Nitrox
- > Nx icon, if Nitrox
- > O2BG with O2 icon, if Nitrox

- A (< 2 sec) to access ALT 2
- Revert to Main in 5 sec, if A not pressed

No Deco Alt 2, information includes (Fig. 78) -

- > Time of Day (hr:min sec), with A (or P) if 12 Hour
- > Temperature with ° icon and graphic F (or C)

- 5 sec or A (< 2 sec), revert to Main

Deep Stop Preview, information includes (Fig. 79) -

- > Stop Depth with graphic FT (or M) and countdown Time as 2:00 (min:sec)
- > Graphic DEEP STOP

- 5 sec, revert to No Deco Main
- L (closure) to activate Backlight

DEEP STOP MAIN, information includes (Fig. 80) -

- > Current Depth with FT (or M) icon
- > Stop Depth with graphic FT (or M) and remaining countdown Time (min:sec)
- > ATR (min) when 60 minutes or less with graphic ATR and Time (clock) icon, blank if no TMT
- > Graphic GAS1 (or 2 or 3), one in use
- > Pressure with PSI (or BAR) and Link icons, if Rcvr and TMT are active, flashing when Link is lost
- > Nx icon, if any Gas is Nitrox
- > TLBG with NI icon

- A (< 2 sec) to access ALTs
- M (2 sec) to access Gas Switching
- S (< 2 sec) to acknowledge alarms
- S (2 sec) to access Compass
- L (closure) to activate Backlight

Deep Stop Alt 1, information includes (Fig. 81) -

- > Max Depth with MAX and FT (or M) icon
- > DTR (hr:min) with graphic NDC (or OTR if less)
- > Graphic EDT with Elapsed Dive Time (hr:min)
- > Graphic FO2 with Set Point for Gas in use
- > Graphic PO2 with current value (ATA), if Nitrox
- > Nx icon, if Nitrox
- > O2BG with O2 icon, if Nitrox

- A (< 2 sec) to access ALT 2
- Revert to Main in 5 sec, if A not pressed



Fig. 76 - NO DECO MAIN

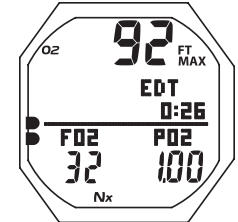

Fig. 77 - NO DECO ALT 1



Fig. 78 - NO DECO ALT 2



Fig. 79 - DEEP STOP PREVIEW

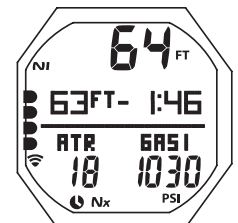

Fig. 80 - DEEP STOP MAIN

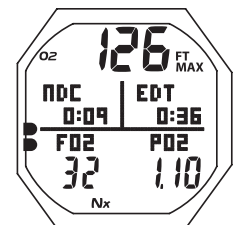

Fig. 81 - DEEP STOP ALT 1

Deep Stop Alt 2, information includes (Fig. 82) -

- > Time of Day (hr:min sec), with A (or P) if 12 Hour
- > Temperature with ° icon and graphic F (or C)

- 5 sec or A (< 2 sec), revert to Main



Fig. 82 - DEEP STOP ALT 2

SAFETY STOP MAIN, information includes (Fig. 83) -

- > Current Depth with FT (or M) icon
- > Stop Depth with graphic FT (or M) and remaining countdown Time (min:sec)
- > ATR (min) when 60 minutes or less with graphic ATR and Time (clock) icon, blank if no TMT
- > Graphic GAS1 (or 2 or 3), one in use
- > Pressure with PSI (or BAR) and Link icons, if Rcvr and TMT are active, flashing when Link is lost
- > Nx icon, if any Gas is Nitrox
- > TLBG with NI icon

- A (< 2 sec) to access ALTs
- M (2 sec) to access Gas Switching
- S (< 2 sec) to acknowledge alarms
- S (2 sec) to access Compass
- L (closure) to activate Backlight

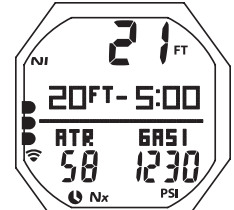

Fig. 83 - SAFETY STOP MAIN

Safety Stop Alt 1, information includes (Fig. 84) -

- > Max Depth with MAX and FT (or M) icon
- > DTR (hr:min) with graphic NDC (or OTR if less)
- > Graphic EDT with Elapsed Dive Time (hr:min)
- > Graphic FO2 with Set Point for Gas in use
- > Graphic PO2 with current value (ATA), if Nitrox
- > Nx icon, if Nitrox
- > O2BG with O2 icon, if Nitrox
- A (< 2 sec) to access ALT 2
- Revert to Main in 5 sec, if A not pressed

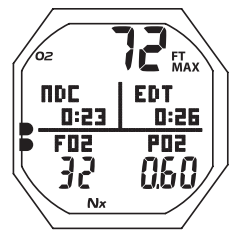

Fig. 84 - SAFETY STOP ALT 1

Safety Stop Alt 2, information includes (Fig. 85) -

- > Time of Day (hr:min sec), with A (or P) if 12 Hour
- > Temperature with ° icon and graphic F (or C)

- 5 sec or A (< 2 sec), revert to Main



Fig. 85 - SAFETY STOP ALT 2

DECOMPRESSION MODE

Decompression mode activates when theoretical No Decompression time and depth limits are exceeded.

Upon Entry into Deco, the Audible will sound and the red LED will flash. The full TLBG and Up Arrow icon will flash (Fig. 86), until the Audible is silenced.

- S (< 2 sec) to silence Audible
 - > Up Arrow icon flashes if 10 FT (3 M) deeper than the required Stop Depth.
 - > Once within 10 FT (3 M) of and below the required Stop Depth (Stop Zone), the full Stop icon (both Arrows with Stop Bar) will be displayed solid.
- L (closure) to activate the Backlight

Managing Deco Stops

To fulfill your decompression obligation, you should make a safe controlled Ascent to a depth slightly deeper than, or equal to, the required Stop Depth indicated and decompress for the Stop Time indicated.

The amount of decompression credit time that you receive is dependent on Depth, with slightly less credit given the deeper you are below the Stop Depth indicated.

You should stay slightly deeper than the Required Stop Depth indicated until the next shallower Stop Depth appears. Then, you can slowly ascend to, but not shallower than that indicated Ceiling Stop Depth.

DECO STOP MAIN, information includes (Fig. 87) -

- > Full Stop icon (Stop Bar with both Arrows) solid
- > Current Depth with FT (or M) icon
- > Stop Depth with graphic FT (or M) and remaining Stop Time (hr:min)
- > ATR (min) when 60 minutes or less with graphic ATR and Time (clock) icon, blank if no TMT
- > Graphic GAS1 (or 2 or 3), one in use
- > Pressure with PSI (or BAR) and Link icons, if Rcvr and TMT are active, flashing when Link is lost
- > Nx icon, if any Gas is Nitrox
- > Full TLBG with NI icon

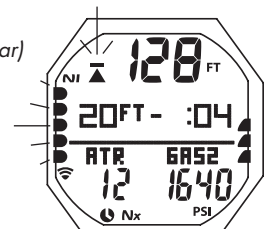

Fig. 86 - DECO ENTRY

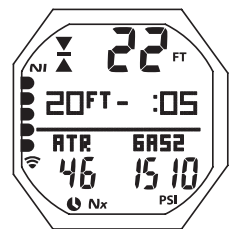

Fig. 87 - DECO STOP MAIN

- A (< 2 sec) to access ALTs
- M (2 sec) to access Gas Switching
- S (< 2 sec) to acknowledge alarms
- S (2 sec) to access Compass
- L (closure) to activate Backlight

Deco Stop Alt 1, information includes (Fig. 88) -

- > Max Depth with MAX and FT (or M) icon
- > Graphic TAT with Total Ascent Time** (hr:min)
- > Graphic EDT with Elapsed Dive Time (hr:min)
- > Graphic FO2 with Set Point for Gas in use
- > Graphic PO2 with current value (ATA), if Nitrox
- > Nx icon, if Nitrox
- > O2BG with O2 icon, if Nitrox

**TAT includes Stop Times at all required Deco Stops plus vertical Ascent Time based on the max rate allowed.

- A (< 2 sec) to access ALT 2
- Revert to Main in 5 sec, if A not pressed

Deco Stop Alt 2, information includes (Fig. 89) -

- > Time of Day (hr:min sec), with A (or P) if 12 Hour
- > Temperature with ° icon and graphic F (or C)

- 5 sec or A (< 2 sec), revert to Main

CONDITIONAL VIOLATION (CV)

Upon ascent above the required Deco Stop Depth, operation will enter CV during which no off gassing credit will be given; with remaining Deco Stop Time and TAT freezing.

The Audible will sound and the red LED will flash. The full TLBG and Down Arrow icon will flash (Fig. 90) until the Audible is silenced, then the TLBG will be solid.

- S (< 2 sec) to silence Audible
 - > Down Arrow icon continues to flash until descent to below required Stop Depth (within Stop Zone), then full Stop icon (Stop Bar with both Arrows) will be on solid.
- L (closure) to activate the Backlight

If descent below the required Deco Stop Depth is made within 5 minutes, operation will resume in Deco with off gassing credit given (Stop Time and TAT decrease).

DELAYED VIOLATION 1 (DV1)

Once above the Deco Stop Depth for more than 5 minutes, operation will enter DV1 which is a continuation of CV**.

Again, the Audible will sound and the red LED will flash. And, the full TLBG will flash (Fig. 91) until the Audible is silenced.

- S (< 2 sec) to silence Audible
 - > Down Arrow icon continues to flash until descent to below required Stop Depth (within Stop Zone), then full Stop icon (Stop Bar with both Arrows) will be on solid.
- L (closure) to activate the Backlight

When descent below the required Deco Stop Depth is made, operation will resume in Deco with off gassing credit given (Stop Time and TAT decrease).

**The difference between CV and DV1 is that DV1 causes operation to enter Violation Gauge Mode 5 minutes after surfacing from that dive.

DELAYED VIOLATION 2 (DV2)

If the calculated Deco obligation requires a Stop Depth between 60 FT (18 M) and 70 FT (21 M), operation will enter DV2 (Fig. 92).

The Audible will sound and the red LED will flash. The full TLBG will flash until the Audible is silenced.

- S (< 2 sec) to silence Audible
 - > Up Arrow icon flashes if 10 FT (3 M) deeper than the required Stop Depth.
 - > Once within 10 FT (3 M) of and below the required Stop Depth (Stop Zone), the full Stop icon (both Arrows with Stop Bar) will be displayed solid.
- L (closure) to activate the Backlight

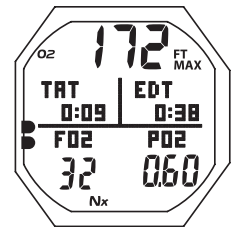

Fig. 88 - DECO STOP ALT 1



Fig. 89 - DECO STOP ALT 2

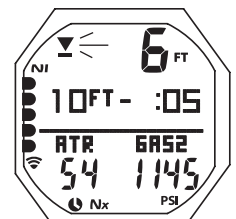

Fig. 90 - CV MAIN (after Audible)

CV, DV1, DV2
ALTs are similar
to Deco

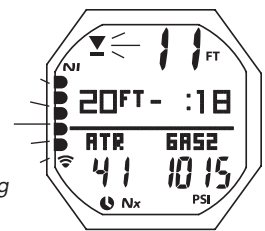

Fig. 91 - DV1 MAIN (during Audible)

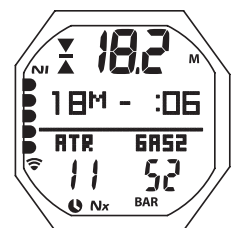

Fig. 92 - DV2 MAIN

DELAYED VIOLATION 3 (DV3)

Upon descent deeper the MOD** (330 FT/100 M), the Audible will sound and the red LED will flash. Also, the Up Arrow will flash, and Current Depth and Max Depth will only indicate 3 dashes (- - -) signifying that you are Out of Range.

**MOD is the Max Operating Depth at which the OC1 can perform (NORM/FREE) nitrogen calculations.

Upon ascending above 330 FT (100 M), Current Depth will be restored, however, Max Depth (on ALT 1) will display 3 dashes for the remainder of that dive. Also, the Log for that dive will display 3 dashes as the Max Depth.

DV3 MAIN, information includes (Fig. 93) -

- > Up Arrow icon, flashing
- > Current Depth, 3 dashes (- - -) flashing, with FT (or M) icon
- > DTR as 0:00 (hr:min) with graphic NDC
- > ATR (min) when 60 minutes or less with graphic ATR and Time (clock) icon, blank if no TMT or ATR is DTR
- > Graphic GAS1 (or 2 or 3), one in use
- > Pressure with PSI (or BAR) and Link icons, if Rcvr and TMT are active, flashing when Link is lost
- > Nx icon, if any Gas is Nitrox
- > TLBG with NI icon
- > VARI while ascending

- A (< 2 sec) to access ALTs
- S (< 2 sec) to acknowledge alarms
- S (2 sec) to access Compass
- L (closure) to activate Backlight



Fig. 93 - DV3 MAIN

DV3 Alt 1, information includes (Fig. 94) -

- > Max Depth as 3 dashes (- - -) with MAX and FT (or M) icons
- > Graphic EDT with Elapsed Dive Time (hr:min)
- > Graphic FO2 with Set Point for Gas in use
- > Graphic PO2 with current value (ATA), if Nitrox
- > Nx icon, if Nitrox
- > O2BG with O2 icon, if Nitrox

- A (< 2 sec) to access ALT 2
- Revert to Main in 5 sec, if A not pressed

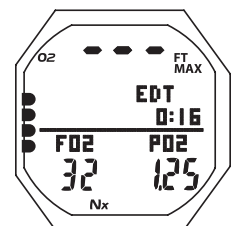

Fig. 94 - DV3 ALT 1

DV3 Alt 2, information includes (Fig. 95) -

- > Time of Day (hr:min sec), with A (or P) if 12 Hour
- > Temperature with ° icon and graphic F (or C)

- 5 sec or A (< 2 sec), revert to Main



Fig. 95 - DV3 ALT 2

VIOLATION GAUGE MODE (VGM)

If a Deco Stop Depth greater than 70 FT (21 M) is required, operation will enter VGM. This would be preceded by DV2.

Operation would then continue in VGM during the remainder of that dive and for 24 hours after surfacing. VGM turns the OC1 into a digital instrument without any decompression or oxygen related calculations or displays.

Upon activation of VGM, the Audible will sound and the red LED will flash during which the full TLBG and Up Arrow icon will flash. When the audible is silent, the TLBG will be removed while the Up Arrow continues to flash until on the surface.

VGM Main, information includes (Fig. 96A/B) -

- > Current Depth with FT (or M) icon
- > Up Arrow icon, flashing until on surface
- > Graphic VIOL (replacing Deco Stop data), flashing until on surface
- > ATR (min) when 60 minutes or less with graphic ATR and Time (clock) icon
- > Graphic TMT 1 (or 2 or 3), one in use, if Rcvr and TMT are active, blank if no TMTs in use
- > Pressure with PSI (or BAR) and Link icons, if Rcvr and TMT are active, flashing when Link is lost
- > TLBG, flashing during Audible then removed
- > VARI while ascending

- A (< 2 sec) to access ALTs
- S (< 2 sec) to acknowledge other type alarms
- S (2 sec) to access Compass
- M (2 sec) to access TMT Switching, if applicable
- L (closure) to activate Backlight

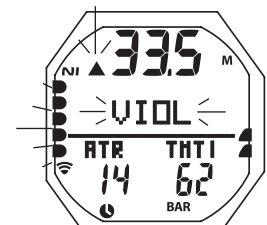

Fig. 96A - VGM MAIN (during Audible)

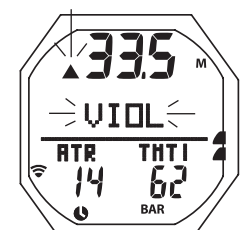

Fig. 96B - VGM MAIN (after Audible)

VGM Alt 1, information includes (Fig. 97) -

- > Max Depth with MAX and FT (or M) icons
- > Graphic EDT with Elapsed Dive Time (hr:min)

- A (< 2 sec) to access ALT 2
- Revert to Main in 5 sec, if A not pressed

VGM Alt 2, information includes (Fig. 98) -

- > Time of Day (hr:min sec), with A (or P) if 12 Hour
- > Temperature with ° icon and graphic F (or C)

- 5 sec or A (< 2 sec), revert to Main

VGM ON SURFACE

The graphic VIOL flashes for the first 10 minutes, then it alternates with NORM (each On 3 seconds, Fig. 99A/B) until DC shut down after 24 hours with no dives.

In the event that a dive is made during the 24 hour period, a full 24 hour surface interval must then be served before all functions are restored.

During that 24 hours, VGM does not allow access to the Set F, Plan, Dsat, and FREE Mode features/screens. All Watch and Compass functions will be allowed.

The Fly countdown timer provides the time remaining before normal operation can resume with full features and functions.

HIGH PO2

Warning >> at Alarm Set Point value minus .20 (1.00 to 1.40)
 Alarm >> at Set Point value, except in Deco then at 1.60 only

When partial pressure of oxygen (PO2) increases to .20 less than the PO2 Alarm Set Point; the Audible sounds, the Up Arrow icon will flash, and the PO2 value with graphic PO2 will flash (in place of NDC) until the Audible is silenced (Fig. 100).

- > After Audible - NDC is restored, Up Arrow icon solid until PO2 decreases below .20 less than the Alarm Set Point.

If PO2 continues to increase and reaches the PO2 Alarm Set Point, the Audible sounds again.

- > The PO2 value with graphic PO2 and Up Arrow icon will flash until PO2 decreases below the Alarm Set Point.

PO2 Alarm Main, information includes (Fig. 101) -

- > Up Arrow icon, flashing until < Set Point, then solid
- > Current Depth with FT (or M) icon
- > PO2 value (ATA) with graphic PO2, flashing until < Set Point, then solid
- > ATR (min) when 60 minutes or less with graphic ATR and Time (clock) icon, blank if no TMT
- > Graphic GAS1 (or 2 or 3), one in use
- > Pressure with PSI (or BAR) and Link icons, if Rcvr and TMT are active, flashing when Link is lost
- > Nx icon
- > TLBG with NI icon
- > VARI while ascending

- A (< 2 sec) to access ALTs
- S (< 2 sec) to acknowledge alarms
- S (2 sec) to access Compass
- M (2 sec) to access Gas Switching
- L (closure) to activate Backlight

PO2 Alarm Alt 1, information includes (Fig. 102) -

- > Max Depth with MAX and FT (or M) icons
- > DTR (hr:min) with graphic NDC (or OTR if less), 0:00 if PO2 is 1.60
- > Graphic EDT with Elapsed Dive Time (hr:min)
- > Graphic FO2 with Set Point for Gas in use
- > Graphic PO2 with current value (ATA)
- > Nx icon
- > O2BG with O2 icon

- A (< 2 sec) to access ALT 2
- Revert to Main in 5 sec, if A not pressed

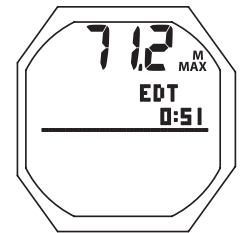

Fig. 97 - VGM ALT 1



Fig. 98 - VGM ALT 2

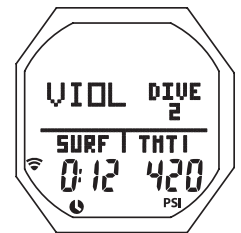

Fig. 99A - VGM SURF MAIN

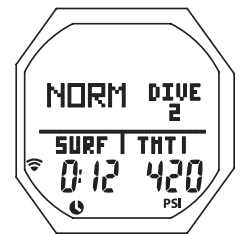

Fig. 99B - VGM SURF MAIN

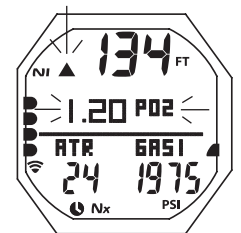

Fig. 100 - PO2 WARNING (during Audible)

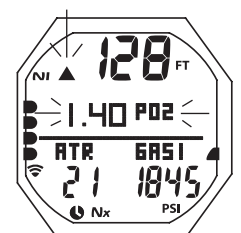

Fig. 101 - PO2 ALARM MAIN

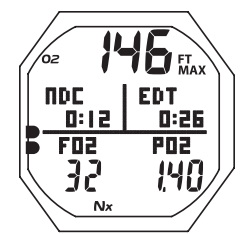

Fig. 102 - PO2 ALARM ALT 1

PO2 Alarm Alt 2, information includes (Fig. 103) -

- > Time of Day (hr:min sec), with A (or P) if 12 Hour
- > Temperature with ° icon and graphic F (or C)

- 5 sec or A (< 2 sec), revert to Main

PO2 during Deco

The PO2 alarm setting does not apply when in Deco.

- > If PO2 reaches 1.60 while at a Deco Stop, the PO2 value (1.60) with graphic PO2 will alternate with Deco Stop Depth/Time once each minute with PO2 on for 10 seconds, Deco on for 50 seconds until PO2 decreases below 1.60, then PO2 will not be displayed.



Fig. 103 - PO2 ALARM ALT 2

HIGH O2

- Warning >> at 80% (240 OTU)
- Alarm >> at 100% (300 OTU)

When O2 accumulation increases to 80%, the Audible sounds, the Up Arrow icon will flash, and the graphic O2 will flash (in place of NDC) until the Audible is silenced (Fig. 104).

- > After Audible - NDC is restored, Up Arrow icon continues to flash until on surface.

If O2 reaches 100%, the Audible sounds again.

- > The full O2BG and graphic O2 will be displayed flashing until on the surface.

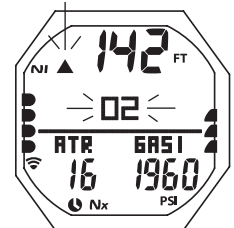

Fig. 104 - HIGH O2 (80%) WARNING (during Audible)

O2 Alarm Main, information includes (Fig. 105) -

- > Up Arrow icon, flashing
- > Current Depth with FT (or M) icon
- > Graphic O2, flashing
- > ATR (min) when 60 minutes or less with graphic ATR and Time (clock) icon, blank if no TMT
- > Graphic GAS1 (or 2 or 3), one in use
- > Pressure with PSI (or BAR) and Link icons, if Rcvr and TMT are active, flashing when Link is lost
- > Nx icon
- > Full O2BG flashing with O2 icon
- > VARI while ascending

- A (< 2 sec) to access ALTs
- S (< 2 sec) to acknowledge alarms
- S (2 sec) to access Compass
- M (2 sec) to access Gas Switching
- L (closure) to activate Backlight

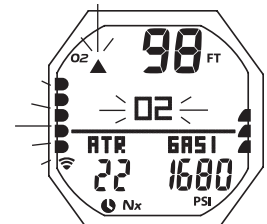

Fig. 105 - HIGH O2 (100%) ALARM MAIN

O2 Alarm Alt 1, information includes (Fig. 106) -

- > Max Depth with MAX and FT (or M) icons
- > Graphic EDT with Elapsed Dive Time (hr:min)
- > Graphic FO2 with Set Point for Gas in use
- > Graphic PO2 with current value (ATA)
- > Nx icon
- > TLBG with NI icon

- A (< 2 sec) to access ALT 2
- Revert to Main in 5 sec, if A not pressed

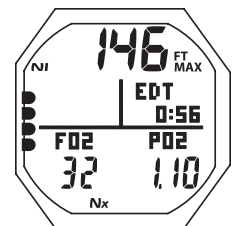

Fig. 106 - O2 ALARM ALT 1

O2 Alarm Alt 2, information includes (Fig. 107) -

- > Time of Day (hr:min sec), with A (or P) if 12 Hour
- > Temperature with ° icon and graphic F (or C)

- 5 sec or A (< 2 sec), revert to Main

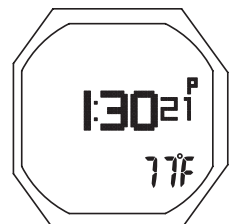

Fig. 107 - O2 ALARM ALT 2

High O2 during Deco

If a High O2 Warning (80%) occurs while at a Deco Stop, the graphic O2 will flash (in place of Stop Depth/Time) until the Audible is silent, then Stop Depth/Time is restored.

If a High O2 Alarm (100%) strikes while at a Deco Stop, the graphic O2 and O2BG will flash (in place of Stop Depth/Time and TLBG) until on the surface. The Up Arrow icon will replace the Deco Stop icon (both arrows with bar) and flash until on the surface.

High O2 on Surface

The graphic O2 flashes (in place of NORM) and the full O2BG is displayed solid until O2 decreases below 100% (to 4 O2BG segments), then the NORM Surface Main screen is restored.

If High O2 occurred during Deco, the graphic O2 flashes with the full O2BG solid for the first 5 minutes, then the O2BG is removed and the graphic O2 alternates with VIOL until O2 decreases below 100%, then the graphic O2 alternates with NORM until 24 hours elapse with no dive.

- > Operation enters VGM.
- > In the event that a dive is made during the 24 hour period, a full 24 hour surface interval must then be served before all functions are restored.
- > During that 24 hours, VGM does not allow access to the Set F, Plan, Dsat, and FREE Mode features/screens. All Watch and Compass functions will be allowed.

 **WARNINGS**

Decompression diving, or diving deeper than 130 FT (39 M), will greatly increase your risk of decompression sickness.

Decompression diving is inherently hazardous and greatly increases your risk of decompression sickness, even when performed according to the dive computer's calculations.

Using an OC1 is no guarantee of avoiding decompression sickness.

The OC1 enters Violation Mode when a situation exceeds its capacity to predict an ascent procedure. These dives represent gross excursions into decompression that are beyond the boundaries and spirit of the OC1's design. If you are following these dive profiles, Oceanic advises that you should not use an OC1.

If you exceed certain limits, the OC1 will not be able to help you get safely back to the surface. These situations exceed tested limits and can result in loss of some functions for 24 hours after the dive in which a violation occurred.

GAS/TMT SWITCHING

OVERVIEW

- > Can only switching when Dive Main screens are displayed.
- > Cannot Switch Gas or TMTs on surface.
- > Cannot Switch Gas or TMTs during alarms.
- > All NORM dives begin with Gas 1.
- > NORM mode defaults to Gas 1 after 10 minutes on the surface.
- > Switching Gas also switches TMTs, if available.

NORM GAS SWITCH Menu, information includes (Fig. 108):

M (2 sec) while a NORM Dive Main is displayed - to access the Menu (Select) screen.

- > Graphic SEL
- > Graphic selections GAS1, GAS2, & GAS3) with FO2 settings

A (< 2 sec) - to step down (forward) through selections

M (< 2 sec) - to step up (back) through selections

S (< 2 sec) - to access selection indicated by Arrow icon (>)

NORM Gas 1 Switch To, information includes (Fig. 109):

- > Graphics SWCH TO** - GAS1
- > Graphic FO2 with Set Point
- > Graphic PO2 with value for Gas 1 FO2
- > Nx icon, if Nitrox

- S (< 2 sec) - to Switch from Gas in use to Gas 1,

> a Search for TMT screen (Fig. 110) is displayed for 10 sec, then operation reverts to Main with Gas 1/TMT 1 selected.

If the Gas/TMT are not switched to the same source as the gas being breathed, ATR will increase to maximum after 1 minute without a change in transmitted Pressure.

>> Gas 2 and/or Gas 3 Switch To are similar.

NORM Gas Switch Alarm**

If a switch to the Gas would result in PO2 => 1.60, the Audible will sound and a warning message will flash (Fig. 111) until it is silenced, then the graphic SWCH TO - will be restored.

Due to the possibility that insufficient air may be available in the Switch From tank, the switch will still be allowed.

If the switch is made, the PO2 alarm will strike. If in Deco, the Up Arrow icon will not flash (you control action to be taken).

GAUG TMT SWITCH Menu, information includes (Fig. 112):

M (2 sec) while a GAUG Dive Main is displayed - to access the Menu (Select) screen.

- > Graphic SEL
- > Graphic selections TMT1, TMT2, & TMT3 with graphic PRESS

A (< 2 sec) to step down (forward) through selections

M (< 2 sec) to step up (back) through selections

S (< 2 sec) to access selection indicated by Arrow icon (>)

TMT 1 Switch To, information includes (Fig. 113):

- > Graphics SWCH TO - TMT1

- S (< 2 sec) to Switch from TMT in use to TMT 1,

> a Search for TMT screen is displayed for 10 sec, then operation reverts to Main with TMT 1 selected

>> TMT 2 and/or TMT 3 Switch To are similar.



Fig. 108 - NORM GAS SWITCH MENU



Fig. 109 - GAS 1 SWCH TO



Fig. 110 - TMT 1 SEARCH



Fig. 111 - GAS SWCH ALARM



Fig. 112 - GAUG TMT SWITCH MENU

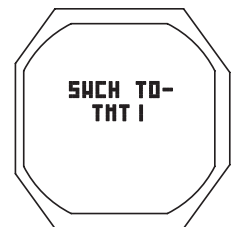
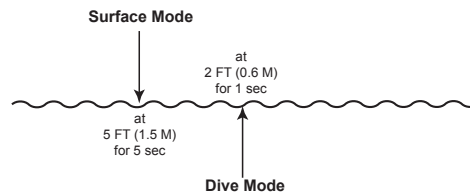
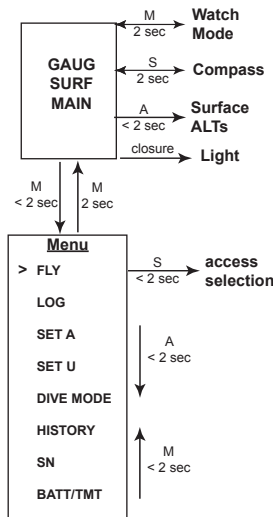

Fig. 113 - TMT 1 SWCH TO

DIGITAL GAUG MODE STRUCTURE

SURFACE



DIVE

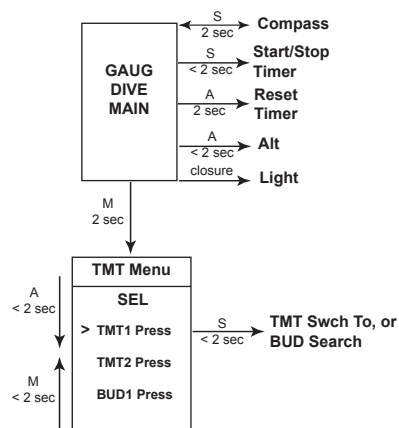

DIGITAL GAUGE

OP MODE

GAUG SURF MAIN, information includes (Fig. 114, 115):

- > Graphic GAUG
- > Graphic DIVE and number of dives completed during that operating period, up to 24 (0 if no dive made yet)
- > Graphic SURF and SI (hr:min) with Time (clock) icon; if no dive yet, this is time since access to GAUG
- > Graphic TMT 1 (or 2 or 3), one in use
- > Tank Pressure with PSI (or BAR) icon, if the Receiver is successfully Linked with an active TMT (Transmitter), 000 flashing after 15 seconds of lost link
- > Link icon, if the Receiver is successfully Linked with a TMT, flashing after 15 seconds of lost Link. (Note that this is the same icon used in Watch Mode to signify that the Daily Alarm is set On.)
- > Battery icon, if voltage is low

- A < 2 sec to access ALT 1 (ALT 2 if no dive yet)
- M < 2 sec to access GAUG Menu
- M 2 sec to access Watch Mode
- S 2 sec to access Compass**
- L (on closure) to activate Backlight

** Compass can only be accessed from Main.



Fig. 114 - GAUG SURF MAIN (no dive yet)



Fig. 115 - GAUG SURF MAIN (after dive 1)

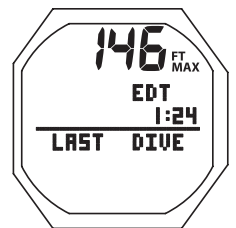

Fig. 116 - GAUG SURF ALT 1 (Last dive's data)



Fig. 117 - GAUG SURF ALT 2

GAUG SURF ALT 1, information includes (Fig. 116):

- > Max Depth with MAX and FT (or M) icons, 2 dashes (- -) if no previous dive
- > Elapsed Dive Time (hr:min) with graphic EDT, 3 dashes (- : - -) if no previous dive
- > Graphic LAST DIVE, indicating that data is from the dive previously conducted while in NORM mode

- A < 2 sec to access ALT 2
- 10 sec, revert to Main if A is not pressed
- L (on closure) to activate Backlight

GAUG SURF ALT 2, information includes (Fig. 117):

- > Time of Day (hr: min sec) with A (or P)
- > Altitude graphic, if EL2 (to EL7), blank if Sea level
- > Temperature with ° icon and graphic F (or C)

- A < 2 sec to access ALT 3 (if set for Nitrox), or revert to Main (if set for Air)
- 5 sec or A < 2 sec, revert to Main
- L (on closure) to activate Backlight

GAUG MENU

- M (< 2 sec) - to access Menu, while viewing Surface Main
- A (< 2 sec) - to step down (forward) through selections
- M (< 2 sec) - to step up (backward) through selections
- S (< 2 sec) - to access selection indicated by Arrow icon (>)
- M (2 sec) any time - to revert to Surface Main
- 2 min no button action - will revert to Surface Main

GAUG MENU
SEL
> FLY
LOG
SET A
SET U
DIVE MODE
HISTORY
SN
BATT/TMT

FLY TIME

Fly Time is a countdown timer that begins counting down 10 minutes after surfacing from a dive from 23:50 to 0:00 (hr:min).

The Fly countdown runs in the background while on the surface.

Fly, information includes (Fig. 118):

- > Time to Fly (hr:min) with graphic FLY
- > Time (clock) icon

- 5 sec or S < 2 sec, revert to Main
- L (on closure) to activate Backlight

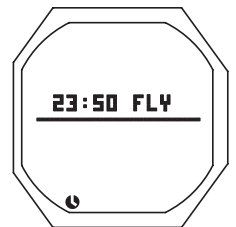

Fig. 118 - FLY (10 min after dive)

SELECT DIVE MODE

S (< 2 sec) - to access Set Dive Mode while the selection Arrow icon (>) is next to it on the FREE Menu

Set Dive Mode, information includes (Fig. 119):

- > Graphics SEL and DIVE MODE
- > Set Point graphics NORM and FREE; Arrow (>) icon next to NORM

- A (< 2 sec) to toggle between the selections
- S (< 2 sec) to save the selection and access that mode's Surface Main screen



Fig. 119 - SET DIVE MODE

Refer to pages 21 through 24 for descriptions of other menu items that are similar to those for NORM.

Upon descent to 5 FT (1.5 M) for 5 seconds, operation will enter GAUG Dive Mode.

GAUG Dive Main, information includes (Fig. 120) -

- > Current Depth with FT (or M) icon
- > Graphic TMR with Run Time (hr:min:sec), 0:00:00 until started, up to 9:59:59
- > Graphic EDT with Elapsed Dive Time (hr:min)
- > Graphic ATR with Time (min) when 60 min or less with Time (clock) icon, blank if no TMT
- > Graphic TMT1 (or 2 or 3), one in use
- > Pressure with PSI (or BAR) and Link icons, if Rcvr and TMT are active, flashing when Link is lost
- > VARI while ascending

- S (2 sec) to access Compass
- S (< 2 sec) to start/stop Run Timer; acknowledge Alarms (which does not operate Timer)
- A (2 sec) to reset Run Timer
- A (< 2 sec) to access ALT
- M (2 sec) to access TMT Switching
- L (closure) to activate Backlight

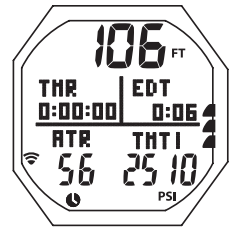

Fig. 120 - GAUG DIVE MAIN

GAUG Dive Alt, information includes (Fig. 121) -

- > Max Depth with MAX and FT (or M) icons
- > Time of Day (hr:min sec), with A (or P) if 12 Hour
- > Temperature with ° icon and graphic F (or C)

- 5 sec or A (< 2 sec), revert to Main



Fig. 121 - GAUG DIVE ALT

DELAYED VIOLATION 3 (DV3)

Upon descent deeper the MOD (660 FT/200 M), the Audible will sound and the red LED will flash. Also, the Up Arrow will flash, and Current Depth and Max Depth will only indicate 3 dashes (- - -) signifying that you are Out of Range.

Upon ascending above 660 FT (200 M), Current Depth will be restored, however, Max Depth (on ALT 1) will display 3 dashes for the remainder of that dive. Also, the Log for that dive will display 3 dashes as the Max Depth.

When operating in Digital Gauge Mode, the Depth range is extended to 660 FT (200 M).

DV3 MAIN, information includes (Fig. 122) -

- > Up Arrow icon, flashing
- > Current Depth, 3 dashes (- - -) flashing, with FT (or M) icon
- > Graphic EDT with Elapsed Dive Time (hr:min)
- > Graphic ATR with Time (min) when 60 min or less with Time (clock) icon, blank if no TMT
- > Graphic TMT1 (or 2 or 3), one in use
- > Pressure with PSI (or BAR) and Link icons, if Rcvr and TMT are active, flashing when Link is lost
- > VARI while ascending

- A (< 2 sec) to access ALT
- S (< 2 sec) to acknowledge alarm
- S (2 sec) to access Compass
- L (closure) to activate Backlight

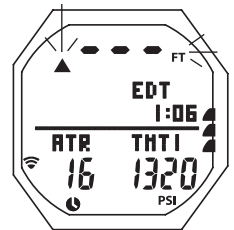

Fig. 122 - GAUG DV 3 MAIN

DV3 Alt, information includes (Fig. 123) -

- > Max Depth, 3 dashes (- - -), with MAX and FT (or M) icons
- > Time of Day (hr:min sec), with A (or P) if 12 Hour
- > Temperature with ° icon and graphic F (or C)

- 5 sec or A (< 2 sec), revert to Main

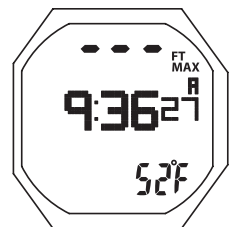
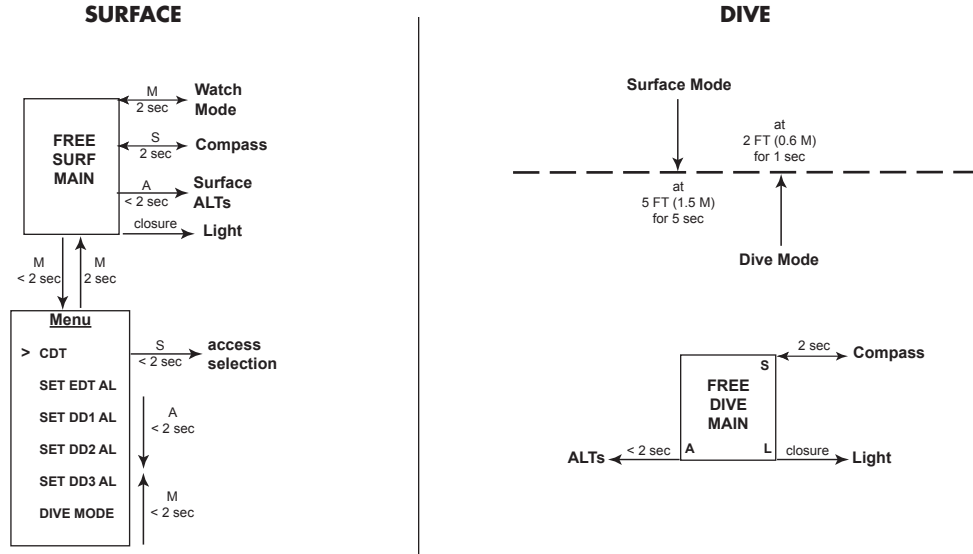

Fig. 123 - GAUG DV 3 ALT

FREE DIVE OP MODE

FREE DIVE MODE STRUCTURE



FREE SURF MAIN, information includes (Fig. 124A/B):

- > Graphic FREE
- > Graphic SURF and SI (min:sec up to 59:59, then hr:min) with Time (clock) icon
- > Graphic DIVE and number of dives completed during that set/series of repetitive dives, up to 99 (0 if no dive made yet)
- > TLBG with NI icon if any nitrogen remaining after NORM or FREE dives in past 24 hours
- > Battery icon, if voltage is low

- A < 2 sec to access ALT 1 (ALT 2 if no dive yet)
- M < 2 sec to access FREE Menu
- M 2 sec to access Watch Mode
- S 2 sec to access Compass**
- L (on closure) to activate Backlight

** Compass can only be accessed from Main.



Fig. 124A - FREE SURF MAIN (no dive yet)



Fig. 124B - FREE SURF MAIN (34 min after dive 4)

FREE SURF ALT 1, information includes (Fig. 125):

- > Max Depth with MAX and FT (or M) icons, 2 dashes (--) if no previous dive
- > Elapsed Dive Time (min:sec) with graphic EDT, 3 dashes (-:-) if no previous dive
- > Graphic LAST DIVE, indicating that data is from the dive previously conducted while in FREE mode

- A < 2 sec to access ALT 2
- 10 sec, revert to Main if A is not pressed
- L (on closure) to activate Backlight

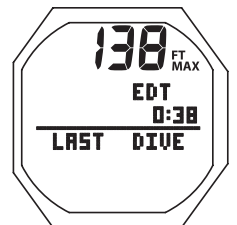

Fig. 125 - FREE SURF ALT 1 (Last dive's data)

FREE SURF ALT 2, information includes (Fig. 126):

- > Time of Day (hr: min sec) with A (or P)
- > Altitude graphic, if EL2 (to EL7), blank if Sea level
- > Temperature with ° icon and graphic F (or C)

- 5 sec or A < 2 sec, revert to Main
- L (on closure) to activate Backlight



Fig. 126 - FREE SURF ALT 2

FREE MENU

- M (< 2 sec) - to access Menu, while viewing Surface Main.
- A (< 2 sec) - to step down (forward) through selections.
- M (< 2 sec) - to step up (backward) through selections.
- S (< 2 sec) - to access selection indicated by Arrow icon (>).
- M (2 sec) any time - to revert to Surface Main.
- 2 min (no button action) - will revert to Surface Main.

CDT (Countdown Timer) STATUS

Upon access, the following is displayed (Fig. 127A) -

- > Graphics CD TMR solid with OFF (or ON) flashing.
- > Countdown Time (hr:min). If OFF, 0:00 or the CDT time if previously set. If ON, the remaining time (min:sec).

- A < 2 sec to step through selections OFF, ON, and SET.
- S < 2 sec to save the selection that is flashing.

- >> If OFF is selected, operation reverts to the Menu.
- >> If ON is selected, operation reverts to the Menu with the time set starting to countdown.
- >> If SET is selected (Fig. 127B), Set CDT is accessed.

Set CDT, information includes (Fig. 128):

- > Graphics SEt and CD TMR
- > CDT (min:sec) with Minutes digits flashing
- > Time (clock) icon

- A (hold) to scroll upward through Minute Set Points at a rate of 8 per second from 0: to 59: in increments of 1: (min).
- A (< 2 sec) to step upward through Set Points one at a time.
- M (< 2 sec) to step back through Set Points one at a time.
- S (< 2 sec) to save the Minute Set Point and flash the Seconds digits.
- A (hold) to scroll upward through Seconds Set Points at a rate of 8 per second from :00 to :59 in increments of :01 (sec).
- A (< 2 sec) to step upward through Set Points one at a time
- M (< 2 sec) to step back through Set Points one at a time.
- S (< 2 sec) to save the CDT Set Point and revert to the CDT Status screen with SET flashing (similar to Fig. 127B).

The CDT will run in the background, while on the surface and during dives, until it counts down to 0:00, or it is turned OFF.

When a set Countdown Time reaches 0:00, the Audible Alarm will sound during which time the graphic CDT will be displayed with 0:00 flashing on the Surface or Dive Main (Fig. 129).

EDT ALARM

Factory set for a fixed 30 seconds, the EDT (Elapsed Dive Time) alarm sounds the Audible every 30 seconds while underwater in FREE Dive Mode.

Set EDT Alarm, information includes (Fig. 130):

- > Graphic EDT
- > Graphic OFF (or ON) flashing

- A < 2 sec to toggle OFF/ON
- S (< 2 sec) to save Set Point and revert to FREE Menu.

DD ALARMS

There are 3 Descending Depth (DD) alarms that can be set at progressively deeper depths. DD2 values deeper than DD1, DD3 values deeper than DD2.

Set DD1 Alarm, information includes (Fig. 131):

- > Depth value with MAX and FT (or M) icons
- > Graphics DD1 AL
- > Graphic OFF (or ON) flashing

- A < 2 sec to toggle OFF/ON
- S (< 2 sec) to save Set Point and flash Depth digits (if ON); or revert to FREE Menu (if OFF), bypassing DD2 and DD3.
- A (hold) to scroll upward through Depth values at a rate of 8 per second from 30 to 330 FT (10 to 100 M) in increments of 10 FT (1 M)
- A (< 2 sec) to step upward through Set Points one at a time
- M (< 2 sec) to step back through Set Points one at a time
- S (< 2 sec) to save the setting and revert to the FREE Menu.



Fig. 127A - CDT STATUS (upon access)

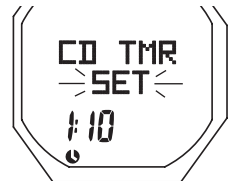

Fig. 127B - CDT STATUS (to access Set, or set/ready)

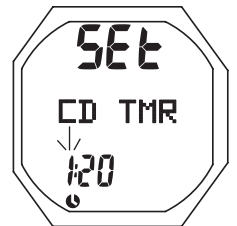

Fig. 128 - SET CDT (min:sec)



Fig. 129 - SURFACE MAIN (during CDT alarm)

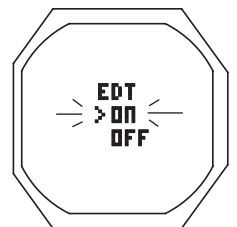

Fig. 130 - SET FREE EDT AL

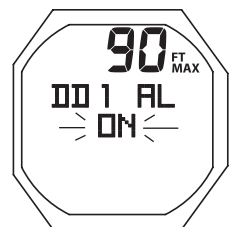

Fig. 131 - SET FREE DD1 AL

Set DD2 Alarm**, information includes (Fig. 132A):

- > Depth value with MAX and FT (or M) icons
- > Graphics DD2 AL
- > Graphic OFF (or ON) flashing

- A (< 2 sec) to toggle OFF/ON
- S (< 2 sec) to save Set Point and flash Depth digits (if ON); or revert to FREE Menu (if OFF), bypassing DD3

** If this screen is accessed when DD1 is set Off, a message (Fig. 132B) will be displayed for 5 seconds, then operation will revert to the FREE Menu.

- A (hold) to scroll up through Depth values at a rate of 8 per second, beginning 1 increment > DD1 Set Point (40 FT/11 M min) to 330 FT (100 M) in increments of 10 FT (1 M)
- A (< 2 sec) to step upward through Set Points one at a time
- M (< 2 sec) to step back through Set Points one at a time
- S (< 2 sec) to save the setting and revert to the FREE Menu.

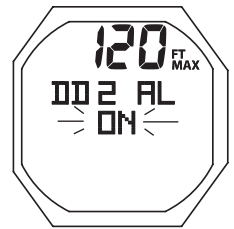

Fig. 132A - SET DD2 AL

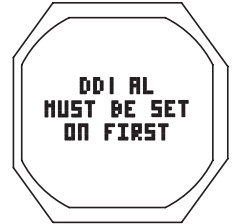

Fig. 132B - SET MESSAGE

Set DD3 Alarm**, information includes (Fig. 133A):

- > Depth value with MAX and FT (or M) icons
- > Graphics DD3 AL
- > Graphic OFF (or ON) flashing

- A (< 2 sec) to toggle OFF/ON
- S (< 2 sec) to save Set Point and flash Depth digits (if ON); or revert to FREE Menu (if OFF)

** If this screen is accessed when DD2 is set Off, a message (Fig. 133B) will be displayed for 5 seconds, then operation will revert to the FREE Menu.

- A (hold) to scroll up through Depth values at a rate of 8 per second, beginning 1 increment > DD2 Set Point (50 FT/12 M min) to 330 FT (100 M) in increments of 10 FT (1 M)
- A (< 2 sec) to step upward through Set Points one at a time
- M (< 2 sec) to step back through Set Points one at a time
- S (< 2 sec) to save the setting and revert to the FREE Menu.

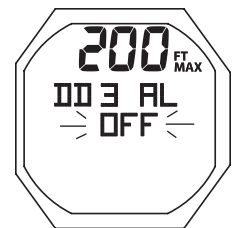

Fig. 133A - SET DD3 AL



Fig. 133B - SET MESSAGE

SELECT DIVE MODE

S (< 2 sec) - to access Set Dive Mode while the selection Arrow icon (>) is next to it on the FREE Menu

Set Dive Mode, information includes (Fig. 134):

- > Graphics SEL and DIVE MODE
- > Set Point graphics NORM and GAUG; Arrow (>) icon next to NORM

- A (< 2 sec) to toggle between the selections
- S (< 2 sec) to save the selection and access that mode's Surface Main screen

To change items that FREE Mode shares with NORM Mode, access the NORM Menu, then Set U, then -

- > Wet Activation
- > Units
- > NDL Basis
- > Conservative Factor
- > Glo Duration



Fig. 134 - SELECT DIVE MODE

Upon descent to 5 FT (1.5 M) for 5 seconds, operation will enter FREE Dive Mode.

FREE Dive Main, information includes (Fig. 135) -

- > Current Depth with FT (or M) icon
- > Graphic NDC with Time Remaining (hr:min)
- > Graphic EDT with Elapsed Dive Time (min:sec)
- > TLBG with NI icon, if any from FREE or NORM dives within last 24 hours

- S (2 sec) to access Compass
- A (< 2 sec) to access ALT 1
- L (closure) to activate Backlight

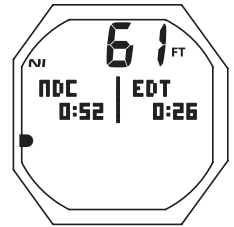

Fig. 135 - FREE DIVE MAIN

FREE Dive Alt 1, information includes (Fig. 136) -

- > Graphics CD TMR
- > Graphic OFF (or ON) flashing
- > Remaining CD (min:sec) with colon flashing if ON and a CD is in progress; 0:00 with colon flashing if the CD is complete; or OFF with the CD previously set
- > Time (clock) icon

- S (< 2 sec) to toggle ON/OFF
- A (< 2 sec) to access ALT 2
- Revert to Main in 10 sec, if A not pressed

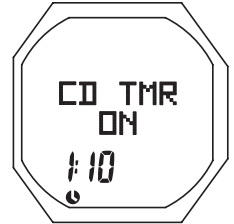

Fig. 136 - FREE DIVE ALT 1

The CDT will run in the background until it counts down to 0:00, or it is turned OFF.

FREE Dive Alt 2, information includes (Fig. 137) -

- > Time of Day (hr:min sec), with A (or P) if 12 Hour
- > Temperature with ° icon and graphic F (or C)

- 5 sec or A (< 2 sec), revert to Main

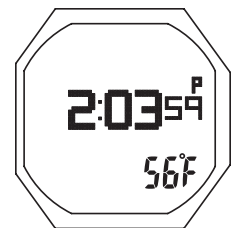

Fig. 137 - FREE DIVE ALT 2

FREE DIVE ALARMS

FREE mode alarms, which are separate from NORM (or GAUG) alarms, sound 1 or 3 times as 3 short beeps then clear.

They cannot be acknowledged or silenced.

FREE CDT Alarm

When a set Countdown Time reaches 0:00, the Audible Alarm will sound during which time the graphic CDT will be displayed with 0:00 flashing on the Main screen (Fig. 138). It will be removed after the audible.

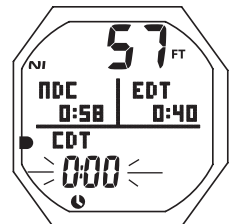

Fig. 138 - DIVE CDT AL

FREE EDT Alarm

When set ON, the EDT alarm activates every 30 seconds during a dive. The Audible will sound during which time the EDT digits will flash on the Main (Fig. 139).

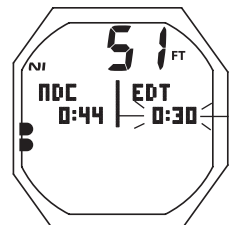

Fig. 139 - EDT AL

FREE Depth Alarms

When set ON, the DD alarms (1, 2, 3) activate at their set Depths. The Audible will sound during which time the Depth digits will flash on the Main (Fig. 140).

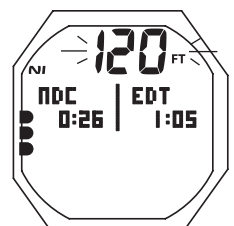

Fig. 140 - DD AL

High Nitrogen Alarms

When nitrogen increases to the caution level (4 segments), the Audible will sound during which time the TLBG and Up Arrow icon will flash on the Main (Fig. 141).

The Up Arrow icon remains on the display until on the surface.

In the event that nitrogen continues to increase and reaches the Deco level; all 5 TLBG segments, the Up Arrow icon, and the graphic VIOL, will flash (Fig. 142A) while the Audible sounds. NDC will be displayed as 0:00.

When the Audible is silenced, the TLBG is removed (Fig. 142B). The Up Arrow icon flashes until on the surface and the graphic VIOL flashes (Fig. 143) until 1 minute elapses on the surface.

After 1 minute on the surface, the graphic VIOL alternates with FREE and dive computer operation locks into FREE Mode for 24 hours. Access to Watch and Compass will be as usual.

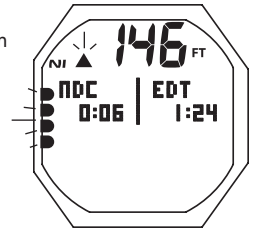

Fig. 141 - TLBG AL

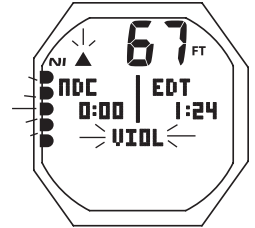

Fig. 142A - FREE VIOLATION (entry into Deco, during Aud)

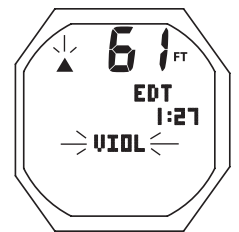

Fig. 142B - FREE VIOLATION (after Aud)

ADDITIONAL INFORMATION PERTAINING TO FREE DIVE MODE

Although breathing apparatus is not utilized for FREE Dive activities, nitrogen tissue loading remains a factor. Nitrogen loading is calculated based upon a fixed FO2 of AIR.

Since a user has the option of alternating between NORM (SCUBA) and FREE Dive activities within a 24 hour period, nitrogen calculations and the displayed value of No Deco Dive Time Remaining (NDC Time) are carried over from one operating mode to the other, which permits the user to maintain awareness of nitrogen absorption and offgasing status.

The mathematical models currently used in the OC1 are based on no decompression/decompression multilevel repetitive dive schedules.

These algorithms do not take into account the physiological changes associated with the high pressures that competitive type Free diving can expose a diver to.



Fig. 143 - FREE VIOLATION (6 sec on surface)

⚠ WARNINGS

Ensure that you know which Operating Mode is selected (NORM, GAUG, or FREE) prior to commencing any dive.

Conducting Free dives within a 24 hour period after conducting SCUBA dives, combined with the effects of multiple rapid Free Dive ascents, increases your risk of decompression sickness. Such activities may result in accelerated entry into decompression which could cause serious injury or death.

Combining competitive type Free dive activities that involve multiple descents/ascents with activities utilizing SCUBA during the same 24 hour period is not recommended. Presently, there is no data relating to such activities.

It is highly recommended that anyone planning to become involved in competitive type Free dive activities obtain proper instruction and training from a recognized Free Diving trainer. It is imperative that the physiological affects be understood and the diver is physically prepared.

COMPASS MODE

COMPASS ICONS

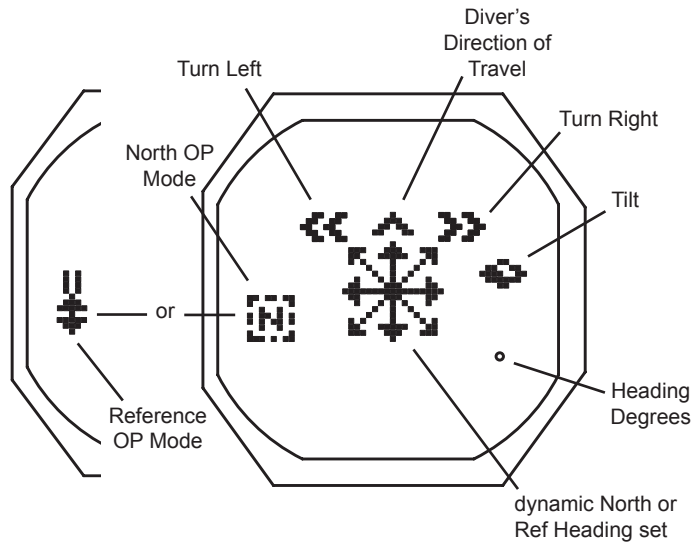

COMPASS MODE SURFACE

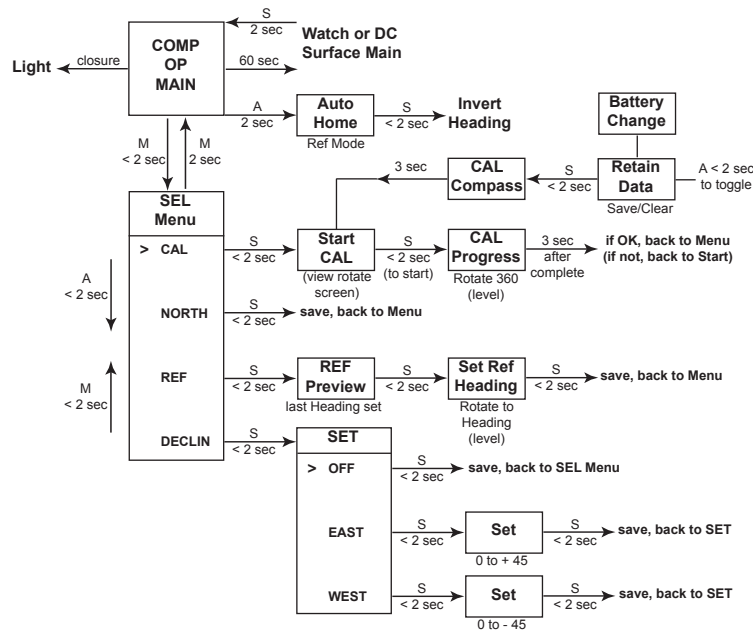

OVERVIEW

- > S (2 sec) - to access** from Watch or Surface Main
- > S (2 sec) - to revert to Watch or Surface Main
- > 60 sec (no button action) - revert to Watch or Surface Main

- > Only active while OP Main is displayed
- > OP (operating) Mode - select North or Reference on surface
- > OP Mode selected - remains until changed.
- > Reference Auto Home - can select on surface or underwater, only while in Reference OP Mode
- > Remains in Auto Home until 10 minutes after surfacing, then reverts to Reference Mode with Heading selected.
- > Surface - can access OP Main, select Ref Auto Home if in Reference, and access Menu.
- > Underwater - can only access OP Main, and select Ref Auto Home if in Reference.
- > Numeric values are always 3 digits (000 to 360°)

Upon accessing the Compass (Fig. 144), the OP (operating) Mode last selected will be displayed (North, Reference, or Ref Auto Home).

During dives, current Depth will also be displayed (Fig. 145).

While on the surface, press M (< 2 sec) to access the Menu to change the OP Mode, Calibrate, or set Declination.

COMPASS MENU

- M (< 2 sec) - to access Menu, while viewing Compass OP Main
- A (< 2 sec) - to step down (forward) through selections
- M (< 2 sec) - to step up (back) through selections
- S (< 2 sec) - to access selection indicated by Arrow icon (>)
- M (2 sec) any time - to revert to OP Main
- 1 min (no button action) - will revert to Watch or DC Main

CALIBRATION

Local magnetic fields can effect display of actual location when reading a digital compass. It may be advantageous to Calibrate the Compass before its first use after purchase, use in new regions, or if inaccuracies are experienced. Calibration will be required when the battery is changed.

CAL Access/Start**, information includes (Fig. 146) -

- > Graphics CAL and ROTATE
- > 360 with ° icon

- S (< 2 sec) - to activate (start) Calibration
- Slowly and steadily rotate the OC1 360° in either direction while maintaining it in a flat level position (keeping it level is critical for accuracy), CAL progress will be displayed.

** The CAL ROTATE screen will also be accessed after the Battery is changed and Data is either saved or cleared.

CAL Progress**, information includes (Fig. 147) -

- > Graphic CAL
- > dotted circle, increasing from 0 to 360° as it is rotated

**Rotation should take about 30 seconds. If not fully rotated in 60 seconds, operation will revert to the Menu.

CAL Complete, information includes (Fig. 148A/B) -

- > Graphic CAL
- > Graphic READY or AGAIN, flashing for 3 seconds

- * READY, means it passed, in which case Calibration is complete and operation reverts to the OP Main.
- * AGAIN, means it failed**, in which case the CAL ROTATE screen will be displayed. Press S (< 2 sec) to repeat the rotation.

**If Calibration fails after 3 attempts, operation will revert to the Watch or Surface Main from which it was accessed. If you then continue operation, the previous successful Calibration will remain in effect.



Fig. 144 - NORTH OP MODE (surface)



Fig. 145 - REF OP MODE (during dive)

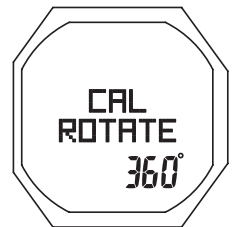
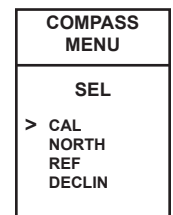

Fig. 146 - START CAL

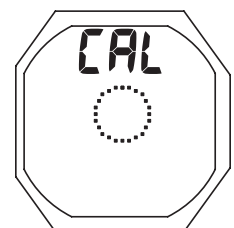

Fig. 147 - CAL PROGRESS



Fig. 148A - CAL FAILED



Fig. 148B - CAL PASSED

NORTH OP MODE

Used for activity involving navigation in which a Heading (direction of travel) is not set prior to diving.

North remains as the default mode until Reference is selected.

North OP Mode, information includes (Fig. 149) -

- > North Mode icon, flashing
 - > Static Arrow icon, diver direction of travel
 - > Dynamic Arrow icon, relative direction of magnetic north
 - > Heading as 001 to 360°, in 1° increments, with quadrant position graphic
- S (< 2 sec) - to save North (icon becomes solid) and display it as the Compass OP Main

Graphic:	Range:
• N	351 to 360 to 010°
• NE	011 to 079°
• E	080 to 100°
• SE	101 to 170°
• S	171 to 190°
• SW	191 to 260°
• W	261 to 280°
• NW	281 to 350°

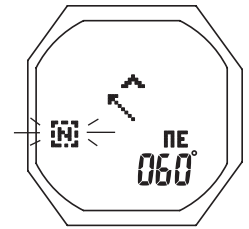

Fig. 149 - NORTH OP MODE (surface)

REFERENCE OP MODE

Used for activity involving navigation in which a Heading, with a reciprocal (Auto Home) course, is set prior to diving.

Upon access from the Menu, the Reference Preview is displayed with the last Heading set, with access to Set Reference Heading.

Reference Preview/Set, information includes (Fig. 150) -

- > Reference Mode icon
 - > Static Arrow icon, diver direction of travel
 - > Dynamic Arrow icon, tracking set Reference direction
 - > Last Reference Heading set prior to dive (001 to 360°) with quadrant position graphic
- S (< 2 sec) - to add the graphic SEt to the display with Reference Mode icon and Heading digits flashing (Fig. 151)
 - Slowly and steadily rotate the OC1 in either direction while maintaining it in a flat level position until the Heading (001 to 360°) required is displayed.
 - S (< 2 sec) - to save Reference as the Compass OP Main
- > Graphic SEt removed, icon and Heading stop flashing



Fig. 150 - REF PREVIEW

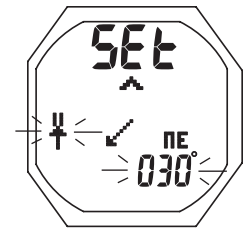

Fig. 151 - SET REFERENCE HEADING

DECLINATION

Magnetic Declination is taken from numbers provided on maps and/or charts that apply to a specific location. The numbers represent the easterly or westerly angular difference (Declination) in degrees between magnetic North and true (geometric or polar) North. A Compass will point to magnetic North unless its reference is adjusted to true North prior to conducting activities.

The Declination Menu displays the graphic SEt with selections OFF, East, and West (Fig. 152).

- S (< 2 sec) - to access selection
- > If OFF, both East and West Declination is set for 0° and operation reverts to the Compass Menu.

Set Declination, information includes (Fig. 153) -

- > Graphics SEt and DECLIN
 - > Graphic EAST + (or WEST -)
 - > Declination value flashing with ° icon
- A (hold) to scroll upward through Set Points at a rate of 8 per second from 0 to 45° in increments of 1°
 - A (< 2 sec) to step upward through Set Points one at a time
 - M (< 2 sec) to step back through Set Points one at a time
 - S (< 2 sec) to save the setting and revert to the Set Declination Menu



Fig. 152 - DECLINATION SET MENU



Fig. 153 - SET DECLIN

COMPASS OPERATION

Once it is Calibrated, Declination is set, the OP Mode is selected, and the course Heading is set (if Reference), the OC1 is ready for operation on the surface or underwater.

- S (2 sec) - to access Compass OP Main while viewing a Surface or Dive Main screen (NORM, GAUG, or FREE) or the Watch Default Time screen

North OP Main, information includes (Fig. 154) -

- > Depth with FT (or M) icon, blank on surface
- > North Mode icon
- > Static Arrow icon, diver direction of travel
- > Dynamic Arrow icon, relative direction of magnetic north
- > Tilt icon (Fig. 154a), while Compass is tipped to either side (left or right) at an angle > 20°. Correct by moving Compass to a level position.
- > Diver's Heading as 001 to 360° with quadrant graphic. *Value removed when the Tilt icon is on.*

- S (2 sec) or 60 sec - reverts to Surface or Dive Main, or Watch Time (whichever one access was from)

Reference OP Main, information includes (Fig. 155) -

- > Depth with FT (or M) icon, blank on surface
- > Reference Mode icon
- > Static Arrow icon, diver direction of travel
- > Turn Arrow icon (left or right) flashing, while > 10° deviation from Heading set
- > Dynamic Arrow icon, tracking set Reference direction
- > Tilt icon, while Compass is tipped to either side (left or right) at an angle > 20°
- > Diver's Heading as 001 to 360° with quadrant graphic. *Value removed when the Tilt icon is on.*

- S (2 sec) or 60 sec - reverts to Surface or Dive Main, or Watch Time (whichever one access was from)
- A (2 sec) - accesses Auto Home Reference Mode which changes and flashes the Mode icon (Fig. 156), then -
- S (2 sec) or 60 sec - reverts to Surface or Dive Main, or Watch Time (whichever one access was from), with Compass operation remaining in Reference Mode
- S (< 2 sec) - inverts the Heading, and during dives changes Compass operation to Auto Home.
- > On surface operation remains in Reference Mode after return to the Surface or Dive Main, or Watch Time (whichever one access was from).

Auto Home Main, information includes (Fig. 157) -

- > Depth with FT (or M) icon
- > Auto Home Mode icon
- > Static Arrow icon, diver direction of travel
- > Turn Arrow icon (left or right) flashing, while > 10° deviation from Heading
- > Dynamic Arrow icon, tracking Home direction
- > Tilt icon, while Compass is tipped to either side (left or right) at an angle > 20°
- > Diver's Heading as 001 to 360° with quadrant graphic. *Value removed when the Tilt icon is on.*

- S (2 sec) or 60 sec - reverts to Dive Main

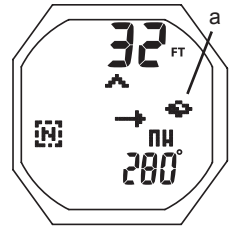

Fig. 154 - NORTH OP MAIN (during dive, Tilt)

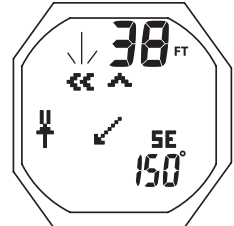

Fig. 155 - REF OP MAIN (during dive, Turn Left)

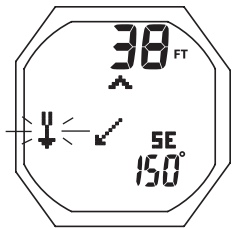

Fig. 156 - REF AUTO HOME

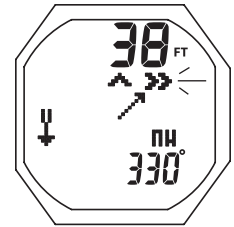

Fig. 157 - REF AUTO HOME



WARNING: You must become thoroughly familiar with setup and operation of the OC1 Digital Compass before using it as your primary device for navigation. Failure to do so could result in serious errors relating to activities involving navigation.

- > Practice on land before use in water.
- > Practice on the surface before use underwater.

REFERENCE



CAUTION: When the procedure provided in this section is used to change the OC1 Battery, you must be sure that the case o-ring is not pinched and that the OC1 is water tight before conducting diving activities. Pre dive pressure testing by an Authorized Oceanic facility is highly recommended.

UPLOADING SETTINGS AND DOWNLOADING DATA

The Settings Upload portion of the Oceanlog PC Interface program can be used to set/change the OC1's Main Time, Date, Set A group (Alarms), and Set U group (Utilities) using the same Interface System. The Set F group (FO2) and FREE Mode Alarms must be entered using the OC1's button controls.

Information available for retrieval (download) from the OC1 to the Download portion of the program includes dive number, SI, max depth, EDT, start date/time, lowest temperature, sampling rate, dive profile, OC1's Set Points, pressure, ATR, O2BG, TLBG, and Gas Switching events/pressures.

Prior to attempting to download data from your OC1 or upload Settings to it, review the Help section of the interface program. Recommended is to print those sections of Help that you consider appropriate for your Interface activities.

A USB Driver is provided on the Oceanlog CD as part of the Interface System.

The OC1 is configured with a Data Port located on the side (Fig. 158a) that enables it to be connected to a PC through a USB port using the special Interface Cable supplied.

To connect the PCI Cable to the OC1:

- > position the connector with the red dot at 12 o'clock.
- > align the pins of the cable connector with the holes in the data port and press the connector into the port (Fig. 159A).
- > turn the connector clockwise until the red dot is at 1 o'clock and it locks in (Fig. 159B), then release it.

The OC1 checks for a connection to the Data Port once every second while the Watch Default Time is displayed. Checks are not made if the Wet Activation contacts are wet.

When the PC Interface cable is plugged in, the graphic PC COMM is displayed with a 2 minute countdown timer that runs until the connection is confirmed, then the graphics PC COMM CONNECTED are displayed until completion of the upload or download operation.

PC requirements:

- IBM® or compatible, Personal Computer with USB Port
- Intel® Pentium 200 MHz or better microprocessor
- Microsoft® Windows® 2000, XP, Vista, or 7
- Super VGA card or compatible video graphics adaptor (256 color or greater) with a minimum 800 X 600 pixel screen area of display settings
- 16MB of available RAM
- 20MB of available hard drive storage
- Mouse
- CD Rom drive
- Printer

For software updates, refer to the Oceanic web site at -

www.OceanicWorldwide.com

For support, call OceanLog Support toll free at -

(866) 732-7877, 8 Am to 5 Pm USA Pacific time.

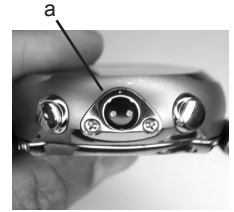

Fig. 158 - OC1 DATA PORT



Fig. 159A - PCI CABLE (insert with dot at 12 o'clock)



Fig. 159B - PCI CABLE (turn dot to 1 o'clock)



TIMER (counting down)

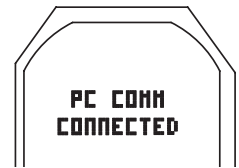

PCI CABLE (connection sensed)

CARE AND CLEANING

Protect your OC1 from shock, excessive temperatures, exposure to chemicals, and tampering. Protect the lens against scratches with a Instrument Lens Protector. Small scratches will naturally disappear underwater.

- Soak and rinse the OC1 in fresh water at the end of each day of diving, and check to ensure that the areas around the Low Pressure (Depth) Sensor (Fig. 160a), PC Interface Data Port (Fig. 160b), and Buttons are free of debris or obstructions. Soak and rinse the Regulator with the Transmitter attached.
- To dissolve salt crystals, use lukewarm water or a slightly acidic bath (50% white vinegar/50% fresh water). After removal from the bath, place the OC1 and the Regulator with Transmitter under gently running water and towel dry before storing.
- Transport your OC1 system cool, dry, and protected.



Fig. 160 - OC1 FRONT

INSPECTIONS AND SERVICE

Your OC1 should be inspected annually by an Authorized Oceanic Dealer who will perform a factory prescribed function check and inspection for damage or wear. To keep the 2 year limited warranty in effect, this inspection must be completed one year after purchase (+/- 30 days).

Oceanic recommends that you continue to have an inspection performed every year to ensure it is working properly. The costs of annual inspections, or inspections relating to water tight integrity, are not covered under the terms of the 2 year limited warranty.

To Obtain Service:

Take your OC1 system to an Authorized Oceanic Dealer or send it to the nearest Oceanic Regional Facility (page xx).

To return your OC1 system to Oceanic:

- Record all dive data in the Log and/or download the data stored in memory. All data will be erased during factory service.
- Package it using a protective cushioning material.
- Include a legible note stating the specific reason for return, your name, address, daytime phone number, serial number(s), and a copy of your original sales receipt and Warranty Registration Card.
- Send freight prepaid and insured using a traceable method to the nearest Oceanic Regional Service Facility, or to Oceanic USA.
- If shipping to Oceanic USA, obtain an RA (Return Authorization) number by contacting Oceanic at 510/562-0500 or send an e-mail to service@oceanicusa.com.
- Non-warranty service must be prepaid. COD is not accepted.
- Additional information is available at the Oceanic web site OceanicWorldwide.com

BATTERY REPLACEMENT

CAUTION: The procedures that follow must be closely adhered to avoid entrance of water into the unit. Damage due to improper Battery replacement (or subsequent leakage of moisture into the unit) is not covered by the OC1's 2 year warranty.

NOTE: The OC1 can be sent to Oceanic Worldwide, Regional Distributor, or Authorized Dealer Service for proper battery change service which includes pressure (depth) and leak testing to the max operating depth. Standard charges for service will apply

The Battery Compartment(s) should only be opened in a dry and clean environment with extreme care taken to prevent the entrance of moisture or dust.

As an additional precautionary measure to prevent formation of moisture in the Battery Compartment(s), it is recommended that the Battery(s) be changed in an environment equivalent to the local outdoor temperature and humidity (e.g., do not change the Battery(s) in an air conditioned environment then take it outside during a hot sunny day).

Inspect the Buttons, Lens, and Housing(s) to ensure they are not cracked or damaged. If there is any sign of moisture in the OC1 or Transmitter(s), DO NOT attempt to use the OC1 for diving (NORM, GAUG, or FREE) until it receives proper service by the Oceanic factory or an Authorized Regional Distributor.

Data Retention

When the OC1 battery is removed, settings and nitrogen/oxygen calculations for repetitive dives will be retained in volatile memory until a new battery is installed. You will have the choice of saving or deleting the data (refer to page 60). The Compass will need to be calibrated after the new battery is installed (refer to page 54).

All parts needed for the battery change that follows are provided in the OC1 Battery Kit available at your Authorized Oceanic Dealer as Oceanic PN 04.6175.35.

OC1 Battery Removal

- There is no need to remove the straps.
- Remove the (4) retaining screws located on the back of the watch case (Fig. 161) by turning them counter clockwise with a small flat tip 3mm screw driver.
- Carefully separate the front and back sections (Fig. 162). The Battery may fall out. **DO NOT** pry apart with tools.
- Turn the case to one side to drop the Battery into your hand. If necessary, gently loosen it with the tip of your finger. **DO NOT** use tools to pry it out, or short the positive (+) top of the Battery (Fig. 163a) to the negative (-) contact under it.
- Discard the Battery according to local regulations governing disposal of Lithium batteries.



Fig. 161 - CASE BACK



Fig. 162 - SEPARATE FRONT AND BACK



Fig. 163 - BATT INSTALLED

Inspection

- Closely check all of the sealing surfaces for any signs of damage that might impair proper sealing.
- Inspect the Buttons, Lens, and Housing to ensure they are not cracked or damaged.

⚠ WARNING: If damage or corrosion is found, return your OC1 to an Authorized Oceanic Dealer, and DO NOT attempt to use it until it has received factory prescribed service.

- Remove the case back O-ring (Fig. 164a) by squeezing the sides. Discard, and do not attempt to reuse it.
 - > It is located around the top rim of the battery case back.
 - > DO NOT use tools to remove the O-ring.
 - > To ensure proper sealing, O-ring replacement is required each time the Battery is replaced.

OC1 Battery Installation

- Very lightly lubricate the new O-ring with silicone grease and place it on the top rim of the battery cover.
- Place a new 3 volt type CR2450 Lithium Battery, negative side down into the Battery cavity and ensure that it is evenly positioned (Fig. 165).
- Carefully align the front and back sections of the case, inserting the guide pin (Fig. 166a) in the guide hole.
- While ensuring that the front and back of the case or properly aligned, firmly press them evenly and completely together (Fig. 167).
- While holding the sections firmly together, insert the (4) retaining screws and tighten them until secure by turning them clockwise with a small flat tip 3mm screw driver.

Testing

- > Ensure that the LCD is clear and sharp in contrast. If any portions are missing or appear dim, or if a Low Battery condition is indicated, return the OC1 with TMTs to an Authorized Oceanic Dealer for evaluation before use.
- > During 24 hours after completion of a dive, the graphic DATA with selections SAVE ? and CLEAR ? will be displayed (Fig. 168) giving you the option to retain or delete Ni-O2 calculations for repetitive dives.
- A (< 2 sec) to toggle between SAVE and CLEAR
- S (< 2 sec) to save the selection
- > Graphics DATA SAVED (or CLEARED) with CAL COMPASS appear for 3 seconds (Fig. 169), then operation reverts to the Compass CAL screen.
- > Calibrate the Compass. Refer to page 54.
- > Verify all Set Points prior to diving.
- Pressurize the Regulator Assembly (and Transmitter).
- Verify that the Link icon is displayed.
- Check the TMT Status screens. Refer to page 25.



Fig. 164 - BATT O-RING



Fig. 165 - BATT INSTALLED

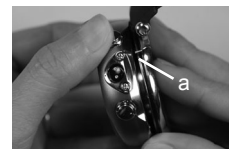

Fig. 166 - ALIGNMENT OF FRONT/BACK



Fig. 167 - PRESS FRONT AND BACK TOGETHER



Fig. 168 - SELECT



Fig. 169 - DATA SAVED

TRANSMITTER

Battery Removal

Locate the Battery cover on the end of the housing:

- Apply a coin to the recessed slot of the cover and turn it counter clockwise out of the housing (Fig. 170).
- Remove the Battery from the and discard according to local regulations governing disposal of Lithium batteries.



Fig. 170 - COVER REMOVAL

Battery Installation

- Lightly lubricate the new Battery cover O-ring with silicone grease and install it onto the cover. DO NOT roll it over the threads, instead stretch it slightly to work it down over the slotted end of the cover into the groove at the base of the threads.

△ NOTE: The O-ring must be a genuine Oceanic part available at an Authorized Oceanic Dealer. Use of any other O-ring will void the warranty.

- Place a new 3 volt, CR2, Lithium Battery positive (+) side into the Battery compartment with the negative (-) end facing out (Fig. 171).
- Ensure that the Battery is properly oriented and the O-ring is evenly seated around the Battery cover (Fig. 172).
- Carefully place the Battery cover with spring into the housing and turn clockwise slowly by hand to ensure proper threading.
- Apply a coin and tighten until secure. The outer surface of the Battery cover should be flush with the outer surface of the housing (Fig. 173).



Fig. 171 - ORIENTATION

To install the TMT (Transmitter) on a Regulator First Stage:

- Lightly lubricate the o-ring and threads of the TMT fitting with a halo carbon based lubricant such as Christo-Lube MCG111.
- Thread the TMT clockwise by hand into the Regulator's HP port (Fig. 174) and tighten until secure with a 5/8" open end wrench.
- Attach the First Stage to a full Scuba Tank and pressurize by slowly opening the tank valve, listening for any indication of air leaking around the fitting.
- If air leakage is present, DO NOT use, take the complete Regulator Assembly to an Authorized Oceanic Dealer for inspection and service.



Fig. 172 - TMT O-RING



Fig. 173 - BATTERY COVER



Fig. 174 -INSTALLING TMT

ALTITUDE SENSING AND ADJUSTMENT

Prior to the first dive of a series of repetitive dives, Altitude (i.e., ambient pressure) is measured upon activation of Dive Surface Mode and every 15 minutes until a dive is made or operation reverts to Watch Mode.

- > While it is operating in Watch modes after a dive, measurements are taken every 15 minutes during the 24 hour period after surfacing.
- > Measurements are only taken when the unit is dry.
- > Two readings are taken, the second reading 5 seconds after the first. The readings must be within 1 foot (30 cm) of each other to record that ambient pressure as the current Altitude.
- > No adjustments are made during any time that the Wet Contacts are bridged.

When diving in high altitude waters from 3,001 to 14,000 feet (916 to 4,270 meters), the OC1 automatically adjusts to these conditions providing corrected Depth, and reduced No Deco and O2 Times at intervals of 1,000 feet (305 meters).

At an elevation of 3,001 feet (916 meters), Depth calibration automatically changes from feet of seawater to feet of fresh water. This is the first adjustment to the algorithm.

When the Conservative Factor feature is set On, NDLs are calculated based upon the next higher 3,000 foot (915 meter) Altitude. All adjustments for Altitudes greater than 11,000 feet (3,355 meters) are then made to allowable dive times for 14,000 feet (4,270 meters). At Sea Level, calculations are based upon an Altitude of 6,000 feet.

The OC1 will not function as a Dive Computer above 14,000 feet (4,270 meters).

TECHNICAL DATA

PZ+ ALGORITHM >> NDLS (HR:MIN) AT ALTITUDE (IMPERIAL)

Altitude (feet)	0		3001		4001		5001		6001		7001		8001		9001		10001		11001		12001		13001		
	to	3000	to	4000	to	5000	to	6000	to	7000	to	8000	to	9000	to	10000	to	11000	to	12000	to	13000	to	14000	
Depth (FT)																									
30	3:17	2:30	2:21	2:14	2:08	2:02	1:57	1:52	1:47	1:39	1:34	1:29													
40	1:49	1:21	1:15	1:11	1:08	1:05	1:02	1:00	0:57	0:55	0:53	0:51													
50	1:05	0:53	0:51	0:49	0:47	0:44	0:42	0:39	0:37	0:35	0:34	0:33													
60	0:48	0:37	0:35	0:33	0:32	0:30	0:28	0:26	0:24	0:23	0:22	0:21													
70	0:35	0:26	0:24	0:23	0:21	0:20	0:19	0:18	0:17	0:16	0:16	0:14													
80	0:26	0:19	0:18	0:17	0:16	0:15	0:14	0:13	0:12	0:11	0:11	0:10													
90	0:19	0:15	0:14	0:13	0:12	0:11	0:10	0:09	0:09	0:09	0:08	0:08													
100	0:16	0:11	0:10	0:10	0:09	0:09	0:08	0:08	0:07	0:07	0:07	0:07													
110	0:12	0:09	0:08	0:08	0:08	0:07	0:07	0:07	0:06	0:06	0:06	0:06													
120	0:10	0:08	0:07	0:07	0:07	0:06	0:06	0:06	0:05	0:05	0:05	0:05													
130	0:08	0:07	0:06	0:06	0:06	0:05	0:05	0:05	0:05	0:05	0:04	0:04													
140	0:07	0:06	0:05	0:05	0:05	0:05	0:05	0:04	0:04	0:04	0:04	0:04													
150	0:06	0:05	0:05	0:05	0:05	0:05	0:04	0:04	0:04	0:04	0:04	0:04													
160	0:06	0:05	0:05	0:04	0:04	0:04	0:04	0:04	0:04	0:04	0:03	0:03													
170	0:05	0:04	0:04	0:04	0:04	0:04	0:04	0:03	0:03	0:03	0:03	0:03													
180	0:05	0:04	0:04	0:04	0:03	0:03	0:03	0:03	0:03	0:03	0:03	0:03													
190	0:04	0:04	0:04	0:03	0:03	0:03	0:03	0:03	0:03	0:03	0:03	0:03													

PZ+ ALGORITHM >> NDLS (HR:MIN) AT ALTITUDE (METRIC)

Altitude (meters)	0		916		1221		1526		1831		2136		2441		2746		3051		3356		3661		3966		
	to	915	to	1220	to	1525	to	1830	to	2135	to	2440	to	2745	to	3050	to	3355	to	3660	to	3965	to	4270	
Depth (M)																									
9	3:37	2:41	2:31	2:23	2:16	2:10	2:04	1:59	1:54	1:50	1:43	1:37													
12	1:55	1:27	1:21	1:15	1:12	1:08	1:05	1:03	1:00	0:58	0:55	0:54													
15	1:08	0:55	0:53	0:51	0:49	0:44	0:42	0:39	0:37	0:36	0:34	0:33													
18	0:50	0:39	0:37	0:35	0:33	0:32	0:30	0:28	0:26	0:24	0:23	0:22													
21	0:36	0:28	0:26	0:24	0:23	0:21	0:20	0:19	0:18	0:17	0:16	0:16													
24	0:27	0:20	0:19	0:18	0:17	0:16	0:15	0:14	0:13	0:12	0:11	0:11													
27	0:20	0:16	0:15	0:13	0:12	0:11	0:10	0:09	0:09	0:09	0:09	0:09													
30	0:16	0:12	0:11	0:10	0:09	0:09	0:08	0:08	0:07	0:07	0:07	0:07													
33	0:13	0:09	0:09	0:08	0:08	0:07	0:07	0:07	0:06	0:06	0:06	0:06													
36	0:10	0:08	0:07	0:07	0:07	0:06	0:06	0:06	0:05	0:05	0:05	0:05													
39	0:09	0:07	0:06	0:06	0:06	0:06	0:05	0:05	0:05	0:05	0:05	0:05													
42	0:08	0:06	0:06	0:05	0:05	0:05	0:05	0:05	0:04	0:04	0:04	0:04													
45	0:06	0:05	0:05	0:05	0:05	0:05	0:04	0:04	0:04	0:04	0:04	0:04													
48	0:06	0:05	0:05	0:04	0:04	0:04	0:04	0:04	0:04	0:04	0:04	0:04													
51	0:05	0:04	0:04	0:04	0:04	0:04	0:04	0:04	0:03	0:03	0:03	0:03													
54	0:05	0:04	0:04	0:04	0:04	0:03	0:03	0:03	0:03	0:03	0:03	0:03													
57	0:05	0:04	0:04	0:03	0:03	0:03	0:03	0:03	0:03	0:03	0:03	0:03													

DSAT ALGORITHM >> NDLS (HR:MIN) AT ALTITUDE (IMPERIAL)

Altitude (feet)	0		3001		5001		6001		7001		8001		9001		10001		11001		12001		13001		
	to	3000	to	4000	to	6000	to	7000	to	8000	to	9000	to	10000	to	11000	to	12000	to	13000	to	14000	
Depth (FT)																							
30	4:20	3:21	3:07	2:55	2:45	2:36	2:28	2:21	2:15	2:10	2:04	1:58											
40	2:17	1:43	1:36	1:30	1:25	1:20	1:16	1:12	1:09	1:06	1:03	1:01											
50	1:21	1:03	1:00	0:58	0:55	0:52	0:48	0:45	0:43	0:41	0:39	0:37											
60	0:57	0:43	0:40	0:38	0:36	0:34	0:33	0:31	0:30	0:29	0:28	0:27											
70	0:40	0:31	0:30	0:28	0:27	0:26	0:24	0:23	0:22	0:20	0:19	0:18											
80	0:30	0:24	0:23	0:21	0:20	0:19	0:18	0:17	0:16	0:16	0:14	0:13											
90	0:24	0:19	0:18	0:17	0:16	0:15	0:14	0:13	0:12	0:11	0:10	0:10											
100	0:19	0:15	0:14	0:13	0:12	0:11	0:10	0:10	0:09	0:09	0:08	0:08											
110	0:16	0:12	0:11	0:10	0:09	0:09	0:08	0:08	0:08	0:07	0:07	0:07											
120	0:13	0:09	0:09	0:08	0:08	0:08	0:07	0:07	0:07	0:06	0:06	0:06											
130	0:11	0:08	0:08	0:07	0:07	0:06	0:06	0:06	0:06	0:05	0:05	0:05											
140	0:09	0:07	0:07	0:06	0:06	0:06	0:06	0:05	0:05	0:05	0:05	0:05											
150	0:08	0:06	0:06	0:06	0:05	0:05	0:05	0:05	0:04	0:04	0:04	0:04											
160	0:07	0:06	0:05	0:05	0:05	0:05	0:05	0:04	0:04	0:04	0:04	0:04											
170	0:07	0:05	0:05	0:05	0:04	0:04	0:04	0:04	0:04	0:04	0:04	0:04											
180	0:06	0:05	0:05	0:04	0:04	0:04	0:04	0:04	0:04	0:04	0:03	0:03											
190	0:05	0:04	0:04	0:04	0:04	0:04	0:04	0:04	0:03	0:03	0:03	0:03											

DSAT ALGORITHM >> NDLS (HR:MIN) AT ALTITUDE (METRIC)

Altitude (meters)	0		916		1221		1526		1831		2136		2441		2746		3051		3356		3661		3966		
	to	915	to	1220	to	1525	to	1830	to	2135	to	2440	to	2745	to	3050	to	3355	to	3660	to	3965	to	4270	
Depth (M)																									
9	4:43	3:37	3:24	3:10	2:58	2:48	2:39	2:31	2:24	2:18	2:12	2:07													

SPECIFICATIONS

CAN BE USED AS

- Watch
- Dive Computer (Air or Nitrox) with up to 3 Transmitters
- Digital Depth Gauge/Timer with up to 3 Transmitters
- Free Dive activity
- Compass

DIVE COMPUTER PERFORMANCE

- Buhlmann ZHL-16c based PZ+, or DSAT based, algorithm
- No Deco limits closely follow PADI RDP
- Decompression in agreement with Buhlmann ZHL-16c and French MN90
- No Deco Deep Stops - Morroni, Bennett
- Deco Deep Stops (not recommended) - Blatteau, Gerth, Gutvik
- Altitude - Buhlmann, IANTD, RDP (Cross)
- Altitude corrections and O2 limits based on NOAA tables

TRANSMITTERS

- Battery and Pressure check
 - > every 2 minutes when asleep
 - > every 2 seconds when awake
- Startup
 - > Pressure => 120 PSI (8 BAR)
 - > Battery => 2.75 volts
- Shutdown
 - > Pressure < 50 PSI (3.5 BAR)

TMT Compatibility with Nitrox

When packaged and shipped from the factory, Oceanic TMTs are rated for use with compressed Air and Nitrox mixtures containing up to 99% O2 by volume and with 100% O2.

OPERATIONAL PERFORMANCE

- Function:** Accuracy:
- Depth ±1% of full scale
 - Timers 1 second per day

Dive Mode Activation:

- Must be in Dive Computer mode, if Wet Activation is set OFF.
- Automatic by immersion in water, if Wet Activation is set ON.
- Cannot be manually activated deeper than 4 FT (1.2 M), if Water Activation is set OFF.
- Cannot operate as a DC at elevations higher than 14,000 feet (4,270 meters)

Dive Counter:

- NORM/GAUG displays Dives #1 to 24, FREE displays #1 to 99 (0 if no dive made yet)
- Resets to Dive #1, upon diving (after 24 hours with no dives)

Dive Log Mode:

- Stores 24 most recent NORM/GAUG dives in memory for viewing
- After 24 dives, adds 25th dive in memory and deletes the older dive

Altitude:

- Operational from sea level to 14,000 feet (4,270 meters) elevation
- Measures ambient pressure every 30 minutes in Watch Mode, when Dive Computer Mode is accessed, and every 15 minutes while in NORM/GAUG/FREE Surface Modes.
- Does not measure ambient pressure when Wet.
- Compensates for Altitudes above sea level beginning at 3,001 feet (916 meters) elevation and every 1,000 feet (305 meters) higher.

Power:

- Watch Battery (1) 3 vdc, CR2450, Lithium battery (Panasonic or equivalent)
- Transmitter Battery (1) 3 vdc, CR2, .75 Ahr, Lithium battery (Duracell model DL-CR2 or equivalent)
- Shelf life Up to 7 years (when shipped from factory in Deep Sleep mode)
- Replacement User replaceable (annual recommended)
- Use Life (OC1) 1 year or 300 dive hours if (2) 1 hour dives per dive day
- Use Life (Transmitter) 300 dive hours if (2) 1 hour dives per dive day

Battery Icon (OC1 only):

- Warning >> icon on solid when <= 2.75 volts, Battery change recommended
- Alarm >> icon on flashing when <= 2.50 volts, change the Battery, will not function as a DC

Operating Temperature:

- Out of the water >> between 20 °F and 140 °F (-6 and 60 °C).
- In storage case provided >> between 14 °F and 158 °F (-8 and 70 °C).
- In the water >> between 28 °F and 95 °F (-2 and 35 °C).

BAR GRAPHS

TLBG	segments	O2BG	segments
• No Deco Normal zone	3	• Normal zone	3
• No Deco Caution zone	1	• Caution zone	1
• Decompression zone	1	• Danger zone	1

VARI	60 FT (18 M) & Shallower			Deeper than 60 FT (18 M)		
	segments	FPM	MPM	segments	FPM	MPM
• Normal Zone	0	0 - 10	0 - 3	0	0 - 20	0 - 6
• Caution Zone	1	11 - 25	3.5 - 7.5	1	21 - 50	6.5 - 15
• Too Fast Zone (flashing)	2	26 - 30	8 - 9	2	51 - 60	15.5 - 18
	3 (all)	> 30	> 9	3 (all)	> 60	> 18

SPECIFICATIONS (CONTINUED)

NUMERIC DISPLAYS:	Range:	Resolution:
• Watch Time of Day	0:00:00 to 23:59:59 hr:min.sec	1 second
• Watch Alternate Time	0:00:00 to 23:59:59 hr:min.sec	1 second
• Watch Time Differential	- 23 hr to 0 to + 23 hr	1 hour
• Watch Countdown Timer	23:59 to 0:00 hr:min	1 minute
• Watch Chrono Lap #	1 to 9	1 (Lap)
• Watch Chrono Lap Time	0:00:00.00 to 99:59:59.99 hr:min:sec_.01 sec	.01 second
• PC Countdown Timer	1:59 to 0:00 min:sec	1 second
• Altitude Level	Sea, EL 1 to EL 7	1 (level)
• Time to Fly	23:50 to 0:00 hr:min (starting 10 min after the dive)	1 minute
• Time to Desat	23:50 to 0:00 hr:min (starting 10 min after the dive)	1 minute
• Temperature	0 to 140°F (-9 to 60°C)	1°F (C)
• Tank Pressure	0 to 5000 PSI (345 BAR)	5 PSI (1 BAR)
• NORM Max Operating Depth	330 FT (100 M)	
• GAUG Max Operating Depth	660 FT (200 M)	
• NORM/GAUG SI Time	0:00 to 23:59 hr:min	1 minute
• NORM/GAUG Dive Number	0 to 24	1
• NORM Depth (display)	0 to 330 FT (100 M)	1 FT (0.1/1 M)
• GAUG Depth (display)	0 to 660 FT (200 M)	1 FT (0.1/1 M)
• NORM/GAUG EDT	0:00 to 9:59 hr:min	1 minute
• NORM DTR (NDC, OTR)	0:00 to 9:59 hr:min	1 minute
• NORM/GAUG ATR	0:00 to 9:59 hr:min	1 minute
• FO2 (1) Set Point	Air, 21 to 50 %	1 %
• FO2 (2, 3) Set Points	Air, 21 to 100 %	1 %
• PO2 Value	0.00 to 5.00 ATA	.01 ATA
• No Deco Deep Stop Time	2:00 to 0:00 min:sec	1 second
• No Deco Safety Stop Time	5:00 to 0:00 min:sec	1 second
• Deco Stop Time	0:00 to 9:59 hr:min	1 minute
• Total Ascent Time	0:00 to 9:59 hr:min	1 minute
• Violation Countdown Timer	23:50 to 0:00 hr:min	1 minute
• FREE SI Time	0:00 to 59:59 min:sec 1:00 to 23:59 hr:min	1 second 1 minute
• FREE Dive Number	0 to 99	1
• FREE Countdown Timer	59:59 to 0:00 min:sec	1 second
• FREE EDT	0:00 to 59:59 min:sec	1 second



WARNING: If your OC1 stops working for any reason while operating as a Dive Computer, it is important that you have anticipated this possibility and are prepared for it. This is an important reason for not pushing the no decompression and oxygen exposure limits, and a critical reason to avoid entering decompression.

If you dive in situations where your trip would be ruined or your safety would be jeopardized by losing the use of your OC1, a backup instrument system is highly recommended.

FCC ID: MH8A

FCC COMPLIANCE:

This equipment complies with Part 15 of the FCC Rules. Operation is subject to the following two conditions: 1.) this equipment may not cause harmful interference, and 2.) this equipment must accept any interference received, including interference that may cause undesired operation.

FCC INTERFERENCE STATEMENT:

This equipment has been tested and found to comply with the limits for an Intentional Radiator, a Class B Digital Device, pursuant to Part 15 of FCC Rules, Title 47 of the Code of Federal Regulations. These rules are designed to provide reasonable protection against harmful interference in a commercial or residential installation. This equipment generates, uses and can radiate radio frequency energy and, if not installed and used in accordance with the instructions, may cause harmful interference to radio communications.

There is no guarantee that interference will not occur in a particular installation. If this equipment does cause interference to radio or television reception, which can be determined by turning the equipment off and on, the user is encouraged to try to correct the interference by one or more of the following measures:

- Reorient or relocate the receiving antenna.
- Increase the separation between the equipment and receiver.
- Connect the equipment to an outlet on a circuit different from that to which the receiver is connected.
- Consult the dealer or an experienced radio/TV technician.



Warning: Changes or modifications to this unit not expressly approved by Oceanic/2002 Design could void the user's authority to operate the equipment.

INSPECTION / SERVICE RECORD

OC1 Serial Number: _____

OC1 Firmware Rev: _____

Transmitter1 Serial Number: _____

Transmitter 2 Serial Number: _____

Transmitter 3 Serial Number: _____

Date of Purchase: _____

Purchased from: _____

Below to be filled in by an Authorized Oceanic Dealer:

Date	Service Performed	Dealer/Technician

OCEANIC WORLD WIDE

OCEANIC USA
 2002 Davis Street
 San Leandro, CA 94577
 Tel: 510/562-0500
 Fax: 510/569-5404
 Web: www.OceanicWorldwide.com
 E-mail: hello@oceanicusa.com

OCEANIC EUROPE
 Augsburg, Germany
 Tel: +49 (0) 821 810342 0 Fax: +49 (0) 821 810342 29
 Web: www.oceanic-eu.com
 E-mail: office@oceanic.de

OCEANIC ASIA PACIFIC
 Singapore
 Tel: +65-6391-1420 Fax: +65-6297-5424
 E-mail: info@oceanicasia.com.sg

OCEANIC UK
 Devon, United Kingdom
 Tel: (44) 1404-891819 Fax: +44 (0) 1404-891909
 Web: www.OceanicUK.com
 E-mail: helpyou@oceanicuk.com

OCEANIC HAWAII and MICRONESIA
 Kapolei, Hawaii
 Tel: 808-682-5488 Fax: 808-682-1068
 E-mail: lbell@oceanicusa.com

OCEANIC AUSTRALIA
 Rosebud, Victoria, Australia
 Tel: 61-3-5986-0100 Fax: 61-3-5986-1760
 Web: www.OceanicAUS.com.au
 E-mail: sales@OceanicAUS.com.au

NOTES

OC1
DIVE COMPUTER
OPERATING MANUAL